

The complete solution for your **WORKBENCH**

By expanding its product portfolio, Weller Tools is setting new benchmarks while laying the foundation for complete expert workbench solutions from a single source. Components in areas including classic soldering applications, extraction and filter systems, tweezers and pliers, screw and robot solutions as well as BGA/QFP and repair applications ensure a coordinated and highly productive electric desktop and installation solution.

FIRST CHOICE FOR CUSTOMERS

Weller continues to transform the results of successful collaboration with our customers and partners in Europe into innovation, expertise and passion for new soldering solutions.

Extraction

The Zero-Smog® extraction unit ensures fresh air and preserves the health of your customers.

Soldering tin

The WSW soldering tin with excellent, even revolutionary, melting properties at low temperatures.



Filtration

FUME EXTRACTION SOLUTIONS

+ LOW NOISE

+ LOW ENERGY CONSUMPTION

+ LARGE FILTER SURFACE FOR LONGER FILTER LIFETIME



Volume extraction

More suitable for applications involving, for example hand soldering, solder baths, hot-air soldering, microsoldering as well as gluing and cleaning work. Weller offers various mobile systems that purify the air for up to 8 workstations.

- Large areas can be covered
- Low maintenance
- Economic for 1 to 8 workstations
- Extraction cabinets
- Remote control



Tip extraction

Weller FE (fume extraction) soldering irons have a smoke tube integrated into the handle. When soldering, the tube is positioned directly above the tip and collects any fumes produced. Fume extraction attachments can be retrofitted to non-fume extraction Weller soldering irons.

- Low investment per workstation
- Extract pollution right at the source
- Up to 20 soldering points with one system (max. 200 m apart)
- Ergonomic with easy access to workpiece
- Minimal air movement



Filtration

Filtration

172 - 242

Volume fume extraction	176
Exhaust hood	200
Easy-Click 60 extraction arms	203
Accessories for extraction arms	211
Accessories for volume extraction	212
Tip extraction	218
Tip extraction accessories	222
Laser extraction	228
Accessories	231
Spare filter	236



Laser extraction

Through its Laserline series, Weller offers mobile fume extraction for all kinds of applications. All systems can be retrofitted with special filters for use in cleanrooms or inkjet printers.

- > Automatic constant flow control (CFC)
- > Interface via USB, RS 232 and optional relay outputs
- > Low-maintenance, brushless turbines
- > Acoustic and visual filter change alarm
- > Individually upgradable with special filters
- > Up to three separate filter components - ensuring low operating costs
- > Thermally recycable main filter housing

ZERO SMOG[®] and LASERLINE fume extraction solutions

WE CARE FOR YOUR ENVIRONMENT.

Why fume extraction?

Many work environments today, including soldering and adhesives applications, create particles and gases that can be harmful to the work place and the environment. To protect the operator, it is important to use an extraction system that is able to separate these particles and gases and then re-circulates the cleaned air back into the work place.

It is important to use the correct safety equipment to remove these hazardous substances. Inhaling fine particles is more dangerous than big particles that get caught more easily because they can block the alveoli in the lungs.



Why fume extraction?
See the video on
www.youtube.com/wellersoldering

Fine particles – A health hazard!

Protect your health and the health of your employees!
Particles and gases are hazardous to health. Fine particles can get into the lungs and cause allergies, asthma or cancer.



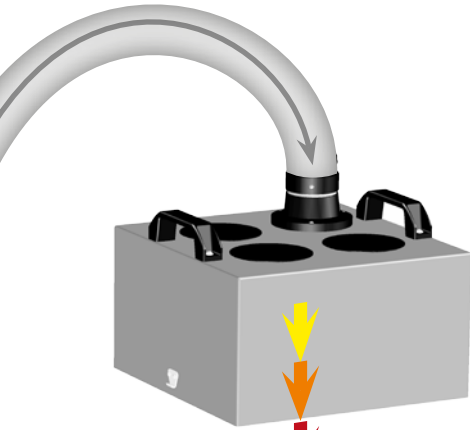

+ **SEPARATE FILTERS
LESS WEAR**

Up to four filters of different permeability separate out particles and gases that are hazardous to health.

Filter classification:	Recommended application
In accordance with EN 1822:2009	M5 For standard applications
	F7 For applications with high flux or dust content
	E12 / H13 For applications with high flux or dust content
	Gas For applications with fumes from adhesives and solvents

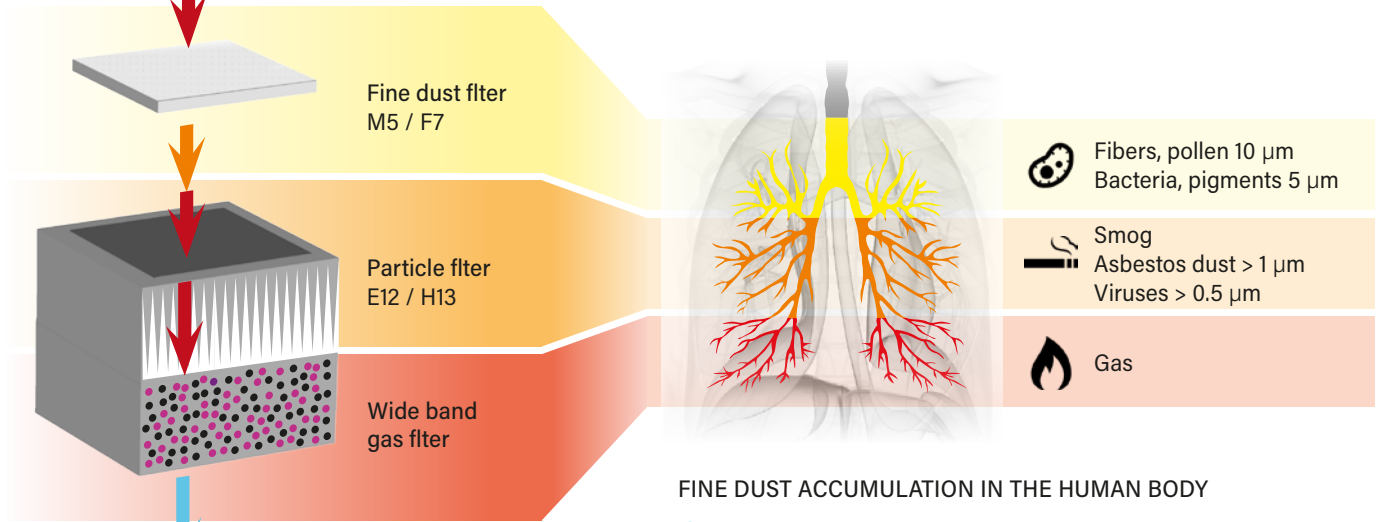

- Fibers, pollen 10 µm
Bacteria, pigments 5 µm
- Smog
Asbestos dust > 1 µm
Viruses > 0.5 µm
- Gas

FINE DUST ACCUMULATION IN THE HUMAN BODY

- The smaller particles are, the deeper they penetrate into the respiratory system
- The deeper particles penetrate, the higher the health risks are
- The smallest particles travel via alveoli into the bloodstream

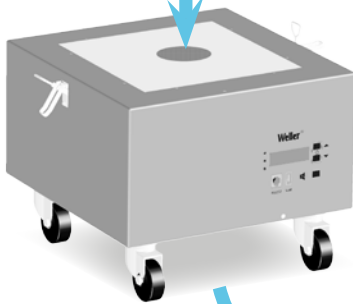

+ **SAVES ENERGY
AND REDUCES
ENERGY COSTS**



End product – clean air – is re-circulated into the workplace.



BEFORE
New filter

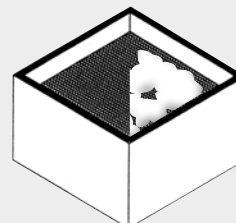

AFTER
90 minutes
soldering with
leadfree solder wire



Volume fume extraction

Weller systems are specifically designed for continuous operation in industrial environments. Care and attention at the design stage plus careful component choice and a high quality manufacturing process have given Weller extraction systems a world wide reputation for reliability and longevity.



SELECTION GUIDE

based on particle- and gas filter capacity

Application	Standard systems			Systems with high gas filter volume		Central systems with automatic flow control	
	Zero Smog EL	Zero Smog 2 Zero Smog TL	MG 130	MG 105	MG 140	Zero Smog 4V	Zero Smog 6V
Hand soldering	✓✓	✓✓	✓✓	✓✓✓	✓✓✓	✓✓✓	✓✓✓
Heavy duty fume applications (solder bath, selective wave)	✓	✓	✓	✓	✓✓	✓✓	✓✓✓
Soldering, gluing, cleaning, filling	✓	✓	✓✓	✓✓✓	✓✓✓	✓✓	✓✓✓
Gluing, Cleaning, Filling	✓	✓	✓✓	✓✓✓	✓✓✓	✓✓✓	✓✓✓
Finedust	✓✓	✓✓	✓✓	✓	✓✓✓	✓✓	✓✓✓
MEK (Methyl Ethyl Keton)			✓	✓✓✓	✓✓✓	✓	✓
VOC (Volatile Organic Com- pounds)			✓	✓✓✓	✓✓✓	✓	✓✓✓
Cleanroom				✓✓✓	✓✓✓		✓✓✓



Zero Smog EL 230V F/G

Fume extraction unit

120 VA

WX
compatibleTRACEability
qualifiedWT
compatibleLOW
SOUND
LEVEL  < 53 db(A)

Order No. FT91 01 069 9

- Fume extraction unit for 1 to 2 workplaces.
- Fine dust pre-filter M5 that can be separately changed, without having to change main filter
- Active carbon foam for effective gas filtering
- Portable fume extraction unit, for placement under or next to the bench-top.
- Easy filter change.



TECHNICAL DATA

Max. capacity	1-2 workplaces
Dimensions W x D x H (inch)	13.19 x 14.17 x 17.52
Dimensions W x D x H (mm)	335 x 360 x 445
Weight (ca) in kg	8.6
Voltage	220-240 V (50/60 Hz)
Heating output	120 VA
Noise level (distance 1 m) dB(A)	< 53
Max Turbine Vacuum (Pa)	2500
Capacity m ³ /h	150
Pre filter	Pre-filter mat class M5
Compact filter	Particle filter H13, Active carbon filter

Scope of supply

Order No.	Model	Description
T005 87 627 01	Filterset H13 for Zero Smog 2, Zero Smog EL, WFE 2ES / CS	Filterset H13 for Zero Smog 2, Zero Smog EL, WFE 2ES / CS

Volume extraction

Tip extraction

Laser extraction

Accessories volume extraction

Spare filter



Volume fume extraction

Zero Smog EL Kit 1

Fume extraction unit with flexible arm and funnel nozzle

120 VA

WT compatible

LOW SOUND LEVEL



< 53 db(A)

Order No. FT91 01 269 9

- Fume extraction unit for 1 to 2 workplaces.
- Fine dust pre-filter M5 that can be separately changed, without having to change main filter
- Active carbon foam for effective gas filtering
- Portable fume extraction unit, for placement under or next to the bench-top.
- Easy filter change.



TECHNICAL DATA

Max. capacity	1-2 workplaces
Dimensions W x D x H (inch)	13.19 x 14.17 x 17.52
Dimensions W x D x H (mm)	335 x 360 x 445
Weight (ca) in kg	8.6
Voltage	220-240 V (50/60 Hz)
Heating output	120 VA
Noise level (distance 1 m) dB(A)	< 53
Max Turbine Vacuum (Pa)	2500
Capacity m ³ /h	150
Pre filter	Pre-filter mat class M5
Compact filter	Particle filter H13, Active carbon filter

Scope of supply	Order No.	Model	Description
		Zero Smog EL Unit	Zero Smog EL Unit
	OF15	OF15 Flexible extraction arm	Extraction arm, flexible, 60 mm for sloped and funnel nozzles, length 1,5 m
	ALFA	ALFA Funnel Nozzle	Easy- Click 60 Funnel nozzle, for flexible and stativ extraction arm, width 230 mm, height 100 mm. To be mounted on an aluminium extraction arm without flexible hose, adapter Z is needed. See extraction arms accessories.
	T005 87 627 01	Filterset H13 for Zero Smog 2, Zero Smog EL, WFE 2ES / CS	Filterset H13 for Zero Smog 2, Zero Smog EL, WFE 2ES / CS
	T005 87 628 46	Fixing clamp	Fixing clamps Ø 63mm, 1 piece, for fixing 60mm extraction arms



Zero Smog 2

Fume extraction unit Zero Smog 2

185 VA  50 db(A)

Order No. FT91 00 469 9

- Economical unit purifies air up to 2 workplaces
- Easy filter exchange
- Quick and simple installation
- Portable fume extraction unit
- The fume extraction unit Zero Smog 2 is easy to install and operate. It is designed as a small, economical central system for two workplaces. The Zero Smog 2 is available in a beneficial kit.



TECHNICAL DATA

Max. capacity	1-2 workplaces
Dimensions W x D x H (inch)	14,17 x 12,99 x 16,33
Dimensions W x D x H (mm)	360 x 330 x 415
Weight (ca) in kg	9
Voltage	220-240 V (50/60 Hz)
Heating output	185 VA
Noise level (distance 1 m) dB(A)	50
Max Turbine Vacum (Pa)	3.000
Capacity m ³ /h	190
Pre filter	Pre filter mat class M5
Compact filter	Particle filter H 13, Active carbon filter

Scope of supply	Order No.	Model	Description
		Zero Smog 2 Unit	Zero Smog 2 Unit

Volume extraction

Tip extraction

Laser extraction

Accessories volume extraction

Spare filter



Volume fume extraction

Zero Smog 2 Kit

Fume extraction unit Zero Smog 2 with Kit 1 Funnel

185 VA

LOW SOUND LEVEL  < 53 db(A)

Order No. FT91 00 669 9



Scope of supply	Order No.	Model	Description
		Zero Smog 2 Unit	Zero Smog 2 Unit
	T005 36 571 99	Kit 1 WF Funnel Nozzle	Easy-Click 60 extraction arm, flexible with funnel nozzle and stop valve

Zero Smog 2 Kit 2 Nozzle

Fume extraction unit Zero Smog 2 with kit 2 nozzle

185 VA

LOW SOUND LEVEL  < 53 db(A)

Order No. FT91 00 769 9



Scope of supply	Order No.	Model	Description
		Zero Smog 2 Unit	Zero Smog 2 Unit
2 x	0F15	0F15 Flexible extraction arm	Extraction arm, flexible, 60 mm for sloped and funnel nozzles, length 1,5 m
2 x	FT-N	FT-N Sloped nozzle	Easy-Click 60 metal sloped nozzle Ø 50mm, length 130 mm.



Zero Smog 2 Kit 2 Funnel

Fume extraction unit Zero Smog 2 with Kit 2 funnel

185 VA  < 53 db(A)

Order No. FT91 00 869 9



Scope of supply	Order No.	Model	Description
		Zero Smog EL Unit	Zero Smog EL Unit
2 x	0F15	0F15 Flexible extraction arm	Extraction arm, flexible, 60 mm for sloped and funnel nozzles, length 1,5 m
2 x	ALFA	ALFA Funnel Nozzle	Easy- Click 60 Funnel nozzle , for flexible and stativ extraction arm, width 230 mm, height 100 mm. To be mounted on an aluminium extraction arm without flexible hose, adapter Z is needed. See extraction arms accessories.
	FT91004699	Zero Smog 2	Fume extraction unit Zero Smog 2

Zero Smog 2 Fume extraction unit for Adhesive fumes

Fume extraction unit Zero Smog 2

185 VA  53 db(A)

Order No. FT91 00 569 9

- Economical unit purifies air up to
- 2 workplaces
- Easy filter exchange
- Quick and simple installation
- Portable fume extraction unit
- The fume extraction unit Zero Smog 2 is easy to install and operate. It is adapted with a adhesive fume filter for gluing applications.





Volume fume extraction

Zero Smog TL

Fume extraction unit Zero Smog TL

120 W **WX** compatible **TRACEability** qualified **WT** compatible
 LOW SOUND LEVEL < 50 db(A)

Order No. FT91 01 369 9

- Low noise levels
- Automated filter change notification system
- Easily operated and easy filter replacement
- Longer service life due to exceptionally large filter surface
- For connection to a WX / WT station a WX / WT Hub is needed



TECHNICAL DATA

Max. capacity	1-2 workplaces
Dimensions W x D x H (inch)	
Dimensions W x D x H (mm)	335 x 330 x 445
Weight (ca) in kg	9
Voltage	220-240 V (50/60 Hz)
Heating output	120 W
Noise level (distance 1 m) dB(A)	<50
Max Turbine Vacuum (Pa)	3.000
Capacity m ³ /h	190
Pre filter	Fine dust prefilter F7
Compact filter	Particle filter H13, Active carbon foam filter



Zero Smog TL Kit 1 FN

Fume extraction unit with flexible extraction arm, extraction hose, stop valve with bench mounting brackets, remote switch and funnel nozzle

120 W

WX
compatibleTRACEability
qualifiedWT
compatible

LOW SOUND LEVEL < 50 db (A)

Order No. FT91 01 569 9



Scope of supply	Order No.	Model	Description
	OF10	OF10 flexible Extraction arm	Easy-Click 60 flexible Extraction arm, 60 mm for sloped and funnel nozzles, length 1 m
	700-3051-ESD	Extraction hose 3 meter	Easy Click 60 Extraction hose Ø 60 mm length: 3 meter
	ALFA	ALFA Funnel Nozzle	Easy- Click 60 Funnel nozzle , for flexible and stativ extraction arm, width 230 mm, height 100 mm. To be mounted on an aluminium extraction arm without flexible hose, adapter Z is needed. See extraction arms accessories.
	FT91000033	On-/Off-Switch	ZSRS Zero Smog Remote Switch
	FT91013699	Zero Smog TL	Fume extraction unit Zero Smog TL

Zero Smog TL Kit 2 FN

Fume extraction unit with 2 flexible extraction arms, 2 fixing clamps for the arms, a remote switch and 2 funnel nozzles

120 W

WX
compatibleTRACEability
qualifiedWT
compatible

LOW SOUND LEVEL < 50 db (A)

Order No. FT91 01 769 9



Scope of supply	Order No.	Model	Description
	2 x OF15	OF15 Flexible extraction arm	Extraction arm, flexible, 60 mm for sloped and funnel nozzles, length 1,5 m
	2 x ALFA	ALFA Funnel Nozzle	Easy- Click 60 Funnel nozzle , for flexible and stativ extraction arm, width 230 mm, height 100 mm. To be mounted on an aluminium extraction arm without flexible hose, adapter Z is needed. See extraction arms accessories.
	FT91000033	On-/Off-Switch	ZSRS Zero Smog Remote Switch
	FT91013699	Zero Smog TL	Fume extraction unit Zero Smog TL
	2 x T005 87 628 46	Fixing clamp	Fixing clamps Ø 63mm, 1 piece, for fixing 60mm extraction arms



Volume fume extraction

Zero Smog TL Kit 2 SN

Fume extraction unit with 2 flexible extraction arms, 2 fixing clamps for the arms, a remote switch and 2 sloped nozzles

120 W **WX** compatible **TRACEability** qualified **WT** compatible
 LOW SOUND LEVEL < 50 db(A)

Order No. FT91 01 669 9



Scope of supply	Order No.	Model	Description
2 x	OF15	OF15 Flexible extraction arm	Extraction arm, flexible, 60 mm for sloped and funnel nozzles, length 1,5 m
2 x	FT-NL	FT-NL Sloped nozzle	Easy -Click 60 metal metal nozzle Ø 60mm, length 130 mm.
	FT91000033	On-/Off-Switch	ZSRS Zero Smog Remote Switch
	FT91013699	Zero Smog TL	Fume extraction unit Zero Smog TL
2 x	T005 87 628 46	Fixing clamp	Fixing clamps Ø 63mm, 1 piece, for fixing 60mm extraction arms

Zero Smog TL with Gas Filter

Zero Smog TL fume extraction unit with Gas Filter

120 W **WX** compatible **TRACEability** qualified **WT** compatible
 LOW SOUND LEVEL < 50 db(A)

Order No. FT91 01 469 9



Scope of supply	Order No.	Model	Description
	T005 87 359 38	Fine dust filter F7 WFE 2S, Zero Smog 4V	Fine dust filter F7 for WFE 2S, Zero Smog 4V



MG 130

Fume extraction unit MG 130

100 W

 LOW SOUND LEVEL  < 52 db(A)

Order No. 130-10 00- ESD

- Unit purifies air up to 2 workplaces
- 100–240 power supply for global use
- Filter alarm and 3 steps speed control
- Small foot print design
- The fume extraction unit MG 130 is easy to install and operate. Is supplied complete ready to place close to the workbench.



TECHNICAL DATA

Max. capacity	1-2 workplaces
Dimensions W x D x H (inch)	18,11 x 8,26 x 19,68
Dimensions W x D x H (mm)	460 x 210 x 500
Weight (ca) in kg	11
Voltage	100 - 240 V, 50/60 Hz
Heating output	100 W
Noise level (distance 1 m) dB(A)	< 52
Max Turbine Vacuum (Pa)	2.300
Capacity m ³ /h	140
Pre filter	Pre filter mat class F7
Compact filter	Particle filter H13, Wide band gas filter (50 % Active carbon + 50 % Chemisorb)
ESD-safe	✓

Scope of supply	Order No.	Model	Description
		MG 130 Unit	MG 130 Unit
	130-2000-ESD	Compact filter MG 130	Particle filter H13 and wide band gas filter, Standard
	130-2010	Fine dust filter F7 MG 130	Fine dust filter F7 for MG 130

Volume extraction

Tip extraction

Laser extraction

Accessories volume extraction

Spare filter



Volume fume extraction

MG 130 Kit Nozzle

Fume extraction unit MG 130 mit Kit Nozzle

100 W LOW SOUND LEVEL < 52 db(A)

Order No. 130-10 55- ESD



Scope of supply	Order No.	Model	Description
		MG 130 Unit	MG 130 Unit
2 x	OF10	OF10 flexible Extraction arm	Easy-Click 60 flexible Extraction arm, 60 mm for sloped and funnel nozzles, length 1 m
	130-2000-ESD	Compact filter MG 130	Particle filter H13 and wide band gas filter, Standard
	130-2010	Fine dust filter F7 MG 130	Fine dust filter F7 for MG 130
2 x	FT-NL	FT-NL Sloped nozzle	Easy -Click 60 metal metal nozzle Ø 60mm, length 130 mm.

MG 130 Kit Funnel

Fume extraction unit MG 130 with Kit Funnel

100 W LOW SOUND LEVEL < 52 db(A)

Order No. FT91 00 010 3



Scope of supply	Order No.	Model	Description
		MG 130 Unit	MG 130 Unit
2 x	OF10	OF10 flexible Extraction arm	Easy-Click 60 flexible Extraction arm, 60 mm for sloped and funnel nozzles, length 1 m
2 x	ALFA	ALFA Funnel Nozzle	Easy- Click 60 Funnel nozzle , for flexible and stativ extraction arm, width 230 mm, height 100 mm. To be mounted on an aluminium extraction arm without flexible hose, adapter Z is needed. See extraction arms accessories.



MG 100S

Fume extraction unit MG 100S

100 W

LOW SOUND LEVEL

< 52 db (A)

Order No. 100-10 00- ESD

- Unit purifies air at up to 2 workplaces
- High Gasfilter volume
- Electronic filter control with filter alarm
- Variable speed setting
- Minimized foot print



TECHNICAL DATA

Max. capacity	1-2 workplaces
Dimensions W x D x H (inch)	18, 11 x 8, 26 x 24, 15
Dimensions W x D x H (mm)	460 x 210 x 610
Weight (ca) in kg	15
Voltage	110 - 240 V, 50/60 Hz
Heating output	100 W
Noise level (distance 1 m) dB(A)	< 52
Max Turbine Vacuum (Pa)	2.300
Capacity m ³ /h	140
Pre filter	
Compact filter	Particle filter H13, Wide band gas filter (50 % Active carbon + 50 % Chemisorb)
ESD-safe	✓

Scope of supply	Order No.	Model	Description
		MG 100S Unit	MG 100S Fume Extraction Unit
	100-2000-ESD	Compact filter MG 100S Standard	Particle filter H13 and wide band gas filter, Standard

Volume extraction

Tip extraction

Laser extraction

Accessories volume extraction

Spare filter



Volume fume extraction

MG 100S Kit 1

Fume extraction unit MG 100S with Kit 2 Funnel

100 W

LOW SOUND LEVEL  < 52 db(A)



Order No. 100-10 56- ESD



Scope of supply	Order No.	Model	Description
		MG 100S Unit	MG 100S Fume Extraction Unit
	100-2000-ESD	Compact filter MG 100S Standard	Particle filter H13 and wide band gas filter, Standard
	T005 36 571 99	Kit 1 WF Funnel Nozzle	Easy-Click 60 extraction arm, flexible with funnel nozzle and stop valve

MG 100S Kit 2

Fume extraction unit MG 100S with Kit 2 Funnel

100 W

LOW SOUND LEVEL  < 52 db(A)



Order No. 100-10 55- ESD



Scope of supply	Order No.	Model	Description
		MG 100S Unit	MG 100S Fume Extraction Unit
2 x	OF15	OF15 Flexible extraction arm	Extraction arm, flexible, 60 mm for sloped and funnel nozzles, length 1,5 m
	100-2000-ESD	Compact filter MG 100S Standard	Particle filter H13 and wide band gas filter, Standard
2 x	ALFA	ALFA Funnel Nozzle	Easy- Click 60 Funnel nozzle , for flexible and stativ extraction arm, width 230 mm, height 100 mm. To be mounted on an aluminium extraction arm without flexible hose, adapter Z is needed. See extraction arms accessories.



MG 100S Kit 3

Fume extraction unit MG 100S with Kit 3

100 W  **< 52 db (A)** 

Order No. 100-10 32- ESD



Scope of supply	Order No.	Model	Description
		MG 100S Unit	MG 100S Fume Extraction Unit
	100-2000-ESD	Compact filter MG 100S Standard	Particle filter H13 and wide band gas filter, Standard
	3-0F15	3-0F15 Flexible extraction arm	Easy- Click 60 Flexible extraction arm, 32 mm length 1,5 Meter

Volume extraction

Tip extraction

Laser extraction

Accessories volume extraction

Spare filter



Volume fume extraction

MG 140

Fume extraction unit MG 140

100 W

LOW SOUND LEVEL < 50 db(A)



Order No. 145-10 00- ESD

- Unit purifies air at up to 2 workplaces
- High Gasfilter volume
- Electronic filter control with alarm function
- Switch power supply 100 - 240 V
- 4 wheels for easy movement



TECHNICAL DATA

Max. capacity	2 workplaces
Dimensions W x D x H (inch)	13,77x13,18x25,78
Dimensions W x D x H (mm)	350 x 335 x 655
Weight (ca) in kg	18
Voltage	110 - 240 V, 50/60 Hz
Heating output	100 W
Noise level (distance 1 m) dB(A)	< 50
Max Turbine Vacuum (Pa)	2.300
Capacity m ³ /h	140
Pre filter	Pre filter mat class F7
Compact filter	Particle filter H13, Wide band gas filter (50 % Active carbon + 50 % Chemisorb)
ESD-safe	✓

Scope of supply	Order No.	Model	Description
		MG 140 Unit	MG 140 Fume Extraction Unit
	145-2000-ESD	Compact filter MG 140	Particle filter H13 and wide band gas filter, Standard
	145-4000	Pre-filter F7 MG 140	Pre-filter bag F8 MG 140



MG 140 for Cleanrooms

Fume extraction unit MG 140 for clean room applications

100 W

 LOW
SOUND
LEVEL

< 50 db(A)

Order No. 145-10 02- ESD

- Unit purifies air at up to 2 workplaces
- High Gasfilter volume
- Electronic filter control with alarm function
- Switch power supply 100 - 240 V
- 4 wheels for easy movement



Scope of supply	Order No.	Model	Description
		MG 140 Unit	MG 140 Fume Extraction Unit
	145-2002-ESD	Particle filter MG 140 Cleanroom	Particle filter H13 and wide band gas filter, Cleanroom
	145-4000	Pre-filter F7 MG 140	Pre-filter bag F8 MG 140
Accessories	Order No.	Model	Description
	700-3057	Remote control for MG units	Remote control for fume extraction unit WFE 2X, MG 100, MG 200, MG 400 with 2 m (78.74 in) cable

Volume extraction

Tip extraction

Laser extraction

Accessories volume extraction

Spare filter



Volume fume extraction

Zero Smog 4V

Fume extraction unit Zero Smog 4V

275 VA
WX compatible
TRACEability qualified
WT compatible

LOW SOUND LEVEL
< 48 db (A)

Order No. T005 36 606 99

- Unit purifies air at up to 4 workplaces
- Constant Flow Control (CFC) guarantees automatic air flow regulation for each working place independent of the connected workplaces
- Electronic filter control with optical and acoustical filter alarm
- Efficiency test via USB port
- 4 wheels to allow easy movement of the unit



TECHNICAL DATA

Max. capacity	1-4 workplaces
Dimensions W x D x H (inch)	13,58x12,79x19,88
Dimensions W x D x H (mm)	345 x 325 x 505
Weight (ca) in kg	19
Voltage	220-240 V (50/60 Hz)
Heating output	275 VA
Noise level (distance 1 m) dB(A)	< 48
Max Turbine Vacuum (Pa)	2.700
Capacity m ³ /h	230
Pre filter	Pre filter mat class F7
Compact filter	Particle filter H13, Wide band gas filter (50 % Active carbon + 50 % Chemisorb)
ESD-safe	✓

Scope of supply	Order No.	Model	Description
		Zero Smog 4V Unit	Zero Smog 4V Unit
	T005 87 359 36	Compact filter Zero Smog 4V, WFE 2S	Compact filter for Zero Smog 4V, WFE 2S
	T005 87 359 38	Fine dust filter F7 WFE 2S, Zero Smog 4V	Fine dust filter F7 for WFE 2S, Zero Smog 4V
	T005 87 627 67	Hose connector straight	Hose connector, straight for WFE 2S / WFE 4S, Zero Smog 4V / Zero Smog 6V and pre filter box



Zero Smog 4V Adhesive fume filter

Fume extraction unit Zero Smog 4V

275 VA **WX** compatible **TRACEability** qualified **WT** compatible
 LOW SOUND LEVEL **48 db (A)**

Order No. T005 36 616 99

- Unit purifies air at up to 4 workplaces
- Constant Flow Control (CFC) guarantees
- automatical air flow regulation for each
- working place independent of the connected
- workplaces
- Electronic filter control with optical and
- acoustical filter alarm
- Efficiency test via USB port
- 4 wheels to allow easy movement of the unit



Scope of supply	Order No.	Model	Description
		Zero Smog 4V Unit	Zero Smog 4V Unit

Volume extraction

Tip extraction

Laser extraction

Accessories volume extraction

Spare filter



Volume fume extraction

Zero Smog 4V Kit 1 Nozzle

Fume extraction unit Zero Smog 4V with Kit 1 Nozzle

275 VA **WX** **TRACEability** **WT**
compatible Welder qualified compatible
 LOW SOUND LEVEL < 48 db (A)

Order No. T005 36 636 99



Scope of supply	Order No.	Model	Description
		Zero Smog 4V Unit	Zero Smog 4V Unit
	T005 36 572 99	Kit 1 Sloped Nozzle	Easy-Click 60 extraction arm with sloped nozzle and stop valve
	T005 87 359 36	Compact filter Zero Smog 4V, WFE 2S	Compact filter for Zero Smog 4V, WFE 2S
	T005 87 359 38	Fine dust filter F7 WFE 2S, Zero Smog 4V	Fine dust filter F7 for WFE 2S, Zero Smog 4V
	T005 87 627 67	Hose connector straight	Hose connector, straight for WFE 2S / WFE 4S, Zero Smog 4V / Zero Smog 6V and pre filter box

Zero Smog 4V Kit 2 Nozzle

Fume extraction Zero Smog 4V with Kit 2 Nozzle

275 VA **WX** **TRACEability** **WT**
compatible Welder qualified compatible
 LOW SOUND LEVEL < 48 db (A)

Order No. T005 36 656 99



Scope of supply	Order No.	Model	Description
		Zero Smog 4V Unit	Zero Smog 4V Unit
2 x	T005 36 572 99	Kit 1 Sloped Nozzle	Easy-Click 60 extraction arm with sloped nozzle and stop valve
	T005 87 359 36	Compact filter Zero Smog 4V, WFE 2S	Compact filter for Zero Smog 4V, WFE 2S
	T005 87 359 38	Fine dust filter F7 WFE 2S, Zero Smog 4V	Fine dust filter F7 for WFE 2S, Zero Smog 4V
2 x	T005 87 627 67	Hose connector straight	Hose connector, straight for WFE 2S / WFE 4S, Zero Smog 4V / Zero Smog 6V and pre filter box



Zero Smog 4V Kit 1 Funnel

Fume extraction Zero Smog 4V with Kit 1 Funnel



Order No. T005 36 626 99



Scope of supply	Order No.	Model	Description
		Zero Smog 4V Unit	Zero Smog 4V Unit
	T005 36 571 99	Kit 1 WF Funnel Nozzle	Easy-Click 60 extraction arm, flexible with funnel nozzle and stop valve
	T005 87 359 36	Compact filter Zero Smog 4V, WFE 2S	Compact filter for Zero Smog 4V, WFE 2S
	T005 87 359 38	Fine dust filter F7 WFE 2S, Zero Smog 4V	Fine dust filter F7 for WFE 2S, Zero Smog 4V
	T005 87 627 67	Hose connector straight	Hose connector, straight for WFE 2S / WFE 4S, Zero Smog 4V / Zero Smog 6V and pre filter box

Zero Smog 4V Kit 2 Funnel

Fume extraction Zero Smog 4V with Kit 2 Funnel



Order No. T005 36 646 99



Scope of supply	Order No.	Model	Description
		Zero Smog 4V Unit	Zero Smog 4V Unit
2 x	T005 36 571 99	Kit 1 WF Funnel Nozzle	Easy-Click 60 extraction arm, flexible with funnel nozzle and stop valve
	T005 87 359 36	Compact filter Zero Smog 4V, WFE 2S	Compact filter for Zero Smog 4V, WFE 2S
	T005 87 359 38	Fine dust filter F7 WFE 2S, Zero Smog 4V	Fine dust filter F7 for WFE 2S, Zero Smog 4V
2 x	T005 87 627 67	Hose connector straight	Hose connector, straight for WFE 2S / WFE 4S, Zero Smog 4V / Zero Smog 6V and pre filter box



Volume fume extraction

Zero Smog 6V

Fume extraction Zero Smog 6V



Order No. T005 36 666 99

- Unit purifies air at up to 8 workplaces
- The Constant Flow Control (CFC) guarantees optimal air flow regulation for each working place independent of the connected workplaces
- Efficiency test via USB port
- Electronic filter control with optical and acoustical filter alarm
- 4 wheels to allow easy movement of the unit



TECHNICAL DATA

Max. capacity	1-8 workplaces
Dimensions W x D x H (inch)	18,11 x 18,11 x 26,18
Dimensions W x D x H (mm)	460 x 460 x 665
Weight (ca) in kg	40
Voltage	230 V, 50/60 Hz (120 V, 60 Hz)
Heating output	460 VA
Noise level (distance 1 m) dB(A)	< 51
Max Turbine Vacuum (Pa)	3.000
Capacity m ³ /h	615
Pre filter	Pre filter mat class F7
Compact filter	Particle filter H13, Wide band gas filter (50 % Active carbon / 50 % Chemisorb)
ESD-safe	✓

Scope of supply	Order No.	Model	Description
		Zero Smog 6V Unit	Zero Smog 6V Unit
	T005 87 358 36	Fine dust filter F7 for Zero Smog 20T, WFE 20D, WFE 4S, Zero Smog 6V, FC 800	Fine dust filter F7 for Zero Smog 20T, WFE 20D, WFE 4S, Zero Smog 6V, FC 800
	T005 87 358 38	Compact filter - WFE 20D, WFE 4S, Zero Smog 6V, Zero Smog 20T, FC 800	Compact filter for WFE 20D, WFE 4S, Zero Smog 6V, Zero Smog 20T, FC 800
	T005 87 627 67	Hose connector straight	Hose connector, straight for WFE 2S / WFE 4S, Zero Smog 4V / Zero Smog 6V and pre filter box



Zero Smog 6V with gas filter

Fume extraction Zero Smog 6V for adhesive fumes



Order No. T005 36 676 99

- Unit purifies air at up to 8 workplaces
- The Constant Flow Control (CFC) guarantees optimal air flow regulation for each working place independent of the connected workplaces
- Efficiency test via USB port
- Electronic filter control with optical and acoustical filter alarm
- 4 wheels to allow easy movement of the unit



Scope of supply	Order No.	Model	Description
		Zero Smog 6V Unit	Zero Smog 6V Unit
	T005 87 358 35	Wide band gas filter	Wide band gas filter for WFE 4S, Zero Smog 6V, FC 800
	T005 87 358 36	Fine dust filter F7 for Zero Smog 20T, WFE 20D, WFE 4S, Zero Smog 6V, FC 800	Fine dust filter F7 for Zero Smog 20T, WFE 20D, WFE 4S, Zero Smog 6V, FC 800
	T005 87 627 67	Hose connector straight	Hose connector, straight for WFE 2S / WFE 4S, Zero Smog 4V / Zero Smog 6V and pre filter box
Accessories	Order No.	Model	Description
	T005 31 191 99	RS 232 Interface cable	Interface cable RS 232, 2 m (78.74 in) for remote control or monitoring by PC (type 1:1) T005 87 359 09
	T005 87 359 09	Remote Control Zero Smog Units	Remote control for fume extraction units WFE 20D, WFE 2S, WFE 4S, WFE 8S, ZS 4V, ZS 6V, ZS 20T with filter status display

Volume extraction

Tip extraction

Laser extraction

Accessories volume extraction

Spare filter



Volume fume extraction

CBC A 230 V 4 x Easy Click 60

Air curtain cabinet CBCA with unique ventilation concept

65 W LOW SOUND LEVEL  < 49 db(A) 

Order No. CBCA 11 2G0 4G6512

- 80 % low running cost against conventional extraction cabins. CBC-A needs only 200 m³/h. Conventional 1000 m³/h
- Mobile System for flexible use on a work bench or trolley.
- Large open front working area with no glas screen.
- Low noise level
- Cabinet interior fittings: Tube lighting
- (2 x 39 W), 230 V. 4 pcs. mains connector 230V



CBC A 160mm hose connector for central ventilation

CBCA 160mm hose connector for central ventilation

65 W LOW SOUND LEVEL  < 49 db(A) 

Order No. CBCA 11 2G0 2G6512

- 80 % low running cost against conventional extraction cabins. CBC-A needs only 200 m³/h. Conventional 1000 m³/h
- Mobile System for flexible use on a work bench or trolley.
- Large open front working area with no glas screen.
- Low noise level
- Cabinet interior fittings: Tube lighting
- (2 x 39 W), 230 V. 4 pcs. mains connector 230V



Accessorie

Order No.	Description
T005 36 666 99	Fume extraction Zero Smog 6V
700-3051-ESD	Easy Click 60 Extraction hose Ø 60 mm length: 3 meter



WESDA 402 Exhaust cabinet 400 liter

Acryl Extraction Cabinet 400 Ltr.



Order No. FT91 00 002 1

- 4 lower shelf
- The ESD safe WESDA Acryl exhaust cabinets are designed to store components during the drying time after gluing or epoxy resin filling processes. The gas emissions are extracted by an extraction unit connected via an easy click 60 hose adapter at the back of the cabinet.
- The ESD safe WESDA Acryl exhaust cabinets are designed to store components during the drying time after gluing or epoxy resin filling processes. The gas emissions are extracted by an extraction unit connected via an easy click 60 hose adapter at the back of the cabinet.



Accessories	Order No.	Model	Description
	700-3041-ESD	Extraction hose 2 meter	Easy Click 60 Extraction hose Ø 60 mm length: 2 meter
	T005 36 616 99	Zero Smog 4V Adhesive fume filter	Fume extraction unit Zero Smog 4V

WESDA 201 Exhaust cabinet 200 liter

Acryl Extraction Cabinaet 200 Ltr.



Order No. FT91 00 002 0

- 2 lower shelf
- The ESD safe WESDA 201 Acryl exhaust cabinets are designed to store components during the drying time after gluing or epoxy resin filling processes. The gas emissions are extracted by an extraction unit connected via an easy click 60 hose adapter at the back of the cabinet.



Accessories	Order No.	Model	Description
	700-3041-ESD	Extraction hose 2 meter	Easy Click 60 Extraction hose Ø 60 mm length: 2 meter
	T005 36 616 99	Zero Smog 4V Adhesive fume filter	Fume extraction unit Zero Smog 4V



Exhaust hood

WEHT Exhaust hood for rising fumes

Extraction hood WEHT with easy-click 60 exhaust top connector

Order No. FT91 00 002 2

- For applications where fumes spread rapidly due to a drafty work environment. The hood can enclose the source, enabling fumes to be captured before they contaminate the workplace. To guarantee sufficient extraction results an extraction unit with minimum 230 m³/h must be connected to the hood.
- Mobile usage on a bench or trolley



Accessories	Order No.	Model	Description
	700-3051-ESD	Extraction hose 3 meter	Easy Click 60 Extraction hose Ø 60 mm length: 3 meter
	FT910 04 699	Zero Smog 2	Fume extraction unit Zero Smog 2
	T005 36 606 99	Zero Smog 4V	Fume extraction unit Zero Smog 4V

WEHB Exhaust hood for glueing / cleaning

WEHB Extraction Hood Bottom for gluing or cleaning applications

Order No. FT91 00 002 3

- Mobil use on bench or trolley
- The work place is covered with a punched steel plate.
- To guarantee sufficient extraction results an extraction unit with minimum 230 m³/h must be connected to the hood.



Accessories	Order No.	Model	Description
	700-3051-ESD	Extraction hose 3 meter	Easy Click 60 Extraction hose Ø 60 mm length: 3 meter
	FT910 05 699	Zero Smog 2 Fume extraction unit for Adhesive fumes	Fume extraction unit Zero Smog 2
	T005 36 616 99	Zero Smog 4V Adhesive fume filter	Fume extraction unit Zero Smog 4V



Zero Smog 4 V Kit Extraction Hood

Set: Fume Extraction Zero Smog 4V and Extraction Hood WEHT with top extraction



Order No. FT91 00 002 4

- The Zero Smog 4V Kit Extraction Hood Top used for applications where fumes spread rapidly due to a drafty work environment. The hood can enclose the source, enabling fumes to be captured before they contaminate the workplace. To guarantee sufficient extraction results an extraction unit with minimum 230 m³/h must be connected to the hood.



Scope of supply	Order No.	Model	Description
	700-3051-ESD	Extraction hose 3 meter	Easy Click 60 Extraction hose Ø 60 mm length: 3 meter
	FT910 00 022	WEHT Exhaust hood for rising fumes	Extraction hood WEHT with easy-click 60 exhaust top connector
	T005 36 606 99	Zero Smog 4V	Fume extraction unit Zero Smog 4V
Accessories	Order No.	Model	Description
	T005 31 191 99	RS 232 Interface cable	Interface cable RS 232, 2 m (78.74 in) for remote control or monitoring by PC (type 1:1) T005 87 359 09

Exhaust hood metal

Exhaust hood, metal



Order No. T005 87 358 45

- 200 x 100 mm (7,87 x 3,93 inch)
- Use with hot air soldering operations uses extraction hose 60
- Metal black
- Inclusive adapter T00 587 627 53



Accessories	Order No.	Model	Description
	T005 87 620 36	Absaugschlauch 60 Meterware	Extension hose, heavy construction, sold by metre (max. length 15m)

Volume extraction

Tip extraction

Laser extraction

Accessories volume extraction

Spare filter



Zero Smog 4V Kit with WEHB extraction hood

Fume extraction Zero Smog 4V with Extraction Hood WEHB, bottom extraction

275 VA **WX** compatible **TRACEability** Weller qualified

LOW SOUND LEVEL 48 db (A)



Order No. FT91 00 002 5

- The Zero Smog 4V kit with WEHB Extraction Hood could be used for gluing or cleaning applications where gases from solvents or glue, lighter than air have to be extracted from below. The work place is covered with a punched steel plate. To guarantee sufficient extraction results an extraction unit with minimum 230 m³/h must be connected to the hoods.

Scope of supply	Order No.	Model	Description
	700-3051-ESD	Extraction hose 3 meter	Easy Click 60 Extraction hose Ø 60 mm length: 3 meter
	FT910 00 023	WEHB Exhaust hood for glueing / cleaning	WEHB Extraction Hood Bottom for gluing or cleaning applications
	T005 36 616 99	Zero Smog 4V Adhesive fume filter	Fume extraction unit Zero Smog 4V

Accessories	Order No.	Model	Description
	T005 31 191 99	RS 232 Interface cable	Interface cable RS 232, 2 m (78.74 in) for remote control or monitoring by PC (type 1:1) T005 87 359 09
	T005 87 359 09	Remote Control Zero Smog Units	Remote control for fume extraction units WFE 20D, WFE 2S, WFE 4S, WFE 8S, ZS 4V, ZS 6V, ZS 20T with filter status display



Easy-Click 60 extraction arms

The Weller Easy Click 60 system is a flexible, easy-to-install connector system for quickly and safely putting together surface extraction systems as you want—without any tools*.

The ESD-safe Easy Click 60 modules provide a variety of connection solutions and are suitable for every application at the workstation. The individual elements can be combined with each other or expanded for individual requirements based on the modular principle.

In addition, thanks to the logical design, the elements can be quickly and flexibly adapted to modified production conditions.

*Except in the case of air intake ports



Kit 1 WF 32

Easy-Click 60 extraction arm with sloped nozzle , length 1 m, Ø 32 mm, stop valve.



Order No. T005 87 627 70

Scope of supply	Order No.	Model	Description
	700-3051-ESD	Extraction hose 3 meter	Easy Click 60 Extraction hose Ø 60 mm length: 3 meter
	T005 36 574 99	Easy-Click 60 Stop valve	Easy-Click 60 Stop valve for table connection of and flex arm and extraction hose including air flow valve and 2 bench mounting brackets.
	T005 36 580 99	WF 32 Extraction Arm 32 mm, with sloped nozzle	Microscope extraction arm, flexible, 32 mm, aluminium nozzle sloped 45°, length 1 meter
	T005 87 628 34	Sloped Nozzle 31 mm	Sloped aluminium nozzle for 32 mm flex arms, Ø 31 mm, length 60 mm

Volume extraction

Tip extraction

Laser extraction

Accessories volume extraction

Spare filter



Kit 1 WF Funnel Nozzle

Easy-Click 60 extraction arm, flexible with funnel nozzle and stop valve



Order No. T005 36 571 99

Scope of supply	Order No.	Model	Description
	0F10	0F10 flexible Extraction arm	Easy-Click 60 flexible Extraction arm, 60 mm for sloped and funnel nozzles, length 1 m
	700-3051-ESD	Extraction hose 3 meter	Easy Click 60 Extraction hose Ø 60 mm length: 3 meter
	ALFA	ALFA Funnel Nozzle	Easy- Click 60 Funnel nozzle , for flexible and stativ extraction arm, width 230 mm, height 100 mm. To be mounted on an aluminium extraction arm without flexible hose, adapter Z is needed. See extraction arms accessories.
	T005 36 574 99	Easy-Click 60 Stop valve	Easy-Click 60 Stop valve for table connection of and flex arm and extraction hose including air flow valve and 2 bench mounting brackets.

Kit 1 Sloped Nozzle

Easy-Click 60 extraction arm with sloped nozzle and stop valve



Order No. T005 36 572 99

Scope of supply	Order No.	Model	Description
	0F10	0F10 flexible Extraction arm	Easy-Click 60 flexible Extraction arm, 60 mm for sloped and funnel nozzles, length 1 m
	700-3051-ESD	Extraction hose 3 meter	Easy Click 60 Extraction hose Ø 60 mm length: 3 meter
	FT-NL	FT-NL Sloped nozzle	Easy -Click 60 metal metal nozzle Ø 60mm, length 130 mm.
	T005 36 574 99	Easy-Click 60 Stop valve	Easy-Click 60 Stop valve for table connection of and flex arm and extraction hose including air flow valve and 2 bench mounting brackets.



Kit 1S WF Sloped Nozzle

Easy-Click 60 2 joint aluminium extraction arm with sloped and stop valve



Order No. T005 36 579 99



Scope of supply	Order No.	Model	Description
	OF07	OF07 Flexible extraction arm	Easy-Click 60 flexible Extraction arm, 60 mm for sloped and funnel nozzles, length 0,7 m. with connectors.
	700-3051-ESD	Extraction hose 3 meter	Easy Click 60 Extraction hose Ø 60 mm length: 3 meter
	FT-NL	FT-NL Sloped nozzle	Easy -Click 60 metal metal nozzle Ø 60mm, length 130 mm.
	T005 36 598 99	2 Joint Extraction Arm	Easy-Click 60 2 joint aluminium extraction arm with valve and ball joint bracket

Kit 1S WF Funnel Nozzle

Easy-Click 60 1 joint aluminium extraction arm with funnel nozzle and stop valve



Order No. T005 87 627 63



Scope of supply	Order No.	Model	Description
	OF07	OF07 Flexible extraction arm	Easy-Click 60 flexible Extraction arm, 60 mm for sloped and funnel nozzles, length 0,7 m. with connectors.
	700-3051-ESD	Extraction hose 3 meter	Easy Click 60 Extraction hose Ø 60 mm length: 3 meter
	ALFA	ALFA Funnel Nozzle	Easy- Click 60 Funnel nozzle , for flexible and stativ extraction arm, width 230 mm, height 100 mm. To be mounted on an aluminium extraction arm without flexible hose, adapter Z is needed. See extraction arms accessories.
	T005 87 627 47	1 Joint Extraction Arm	Easy-Click 60 1 joint aluminium extraction arm with valve and bench mounting brackets

Volume extraction

Tip extraction

Laser extraction

Accessories volume extraction

Spare filter



KIT 1 EA FN

KIT 1 Extraction arm (60 mm, length 1,5 m)
with an ALFA funnel nozzle and a fixing clamp

Order No. FT91 00 003 7



Scope of supply	Order No.	Model	Description
	OF15	OF15 Flexible extraction arm	Extraction arm, flexible, 60 mm for sloped and funnel nozzles, length 1,5 m
	ALFA	ALFA Funnel Nozzle	Easy- Click 60 Funnel nozzle , for flexible and stativ extraction arm, width 230 mm, height 100 mm. To be mounted on an aluminium extraction arm without flexible hose, adapter Z is needed. See extraction arms accessories.
	T005 87 628 46	Fixing clamp	Fixing clamps Ø 63mm, 1 piece, for fixing 60mm extraction arms

Extraction Tripod

Easy-Click 60 1 joint extraction tripod



Order No. FT91 00 002 6

- For volume extraction in higher work area like soldering in switch cabinets. Ready for mounting on Zero Smog 4 V and WFE 2S. Measurements with extraction unit: High 1300 mm, Joint 213 mm





1 Joint Extraction Arm

Easy-Click 60 1 joint aluminium extraction arm with valve and bench mounting brackets



Order No. T005 87 627 47



2 Joint Extraction Arm

Easy-Click 60 2 joint aluminium extraction arm with valve and ball joint bracket



Order No. T005 36 598 99



Ball Joint Extraction Arm

Easy-Click 60 ball joint aluminium extraction arm with valve and ball joint bracket



Order No. FT-3 44 6



Volume extraction

Tip extraction

Laser extraction

Accessories volume extraction

Spare filter



Volume fume extraction | Easy-Click 60 extraction arms

1 Joint Double Extraction Arm

Easy-Click 60 1 joint double aluminium extraction arm With valve and bench mounting brackets



Order No. FT-4 40 2



Extension Rotating Joint

Easy-Click 60 extension joint rotating



Order No. FT-3 41 7

- 1 Joint Extension
- For all Easy-click aluminium extraction arms





Extension Rotating Joint Sloped Nozzle

Easy-Click 60 extension rotating joint



Order No. FT-3 47 5

- 1 Joint Extension
- With length adjustable sloped 45° P nozzle for all Easy-click aluminium extraction arms

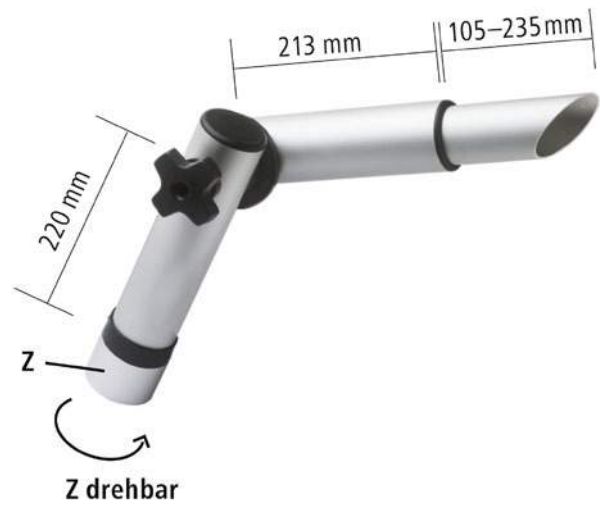

1 Joint Wall Mounting Arm

Easy-Click 60 1 joint aluminium extraction arm with valve



Order No. FT-3 47 0



Volume extraction

Tip extraction

Laser extraction

Accessories volume extraction

Spare filter



WF 32 Extraction Arm 32 mm, with sloped nozzle



Order No.	Description
T005 36 580 99	Microscope extraction arm, flexible, 32 mm, aluminium nozzle sloped 45°, length 1 meter

Flexible extraction arms, □ 32 mm



Order No.	Description
3-0F05	Easy-Click 60 flexibler extraction arm, 32 mm length 0,5 Meter
3-0F07	Easy-Click 60 Flexible extraction arm, 32 mm length 0,7 Meter
3-0F15	Easy- Click 60 Flexible extraction arm, 32 mm length 1,5 Meter

Flexible Extraction arm Ø 60 mm











Order No.	Description
0F05	Easy-Click 60 flexible Extraction arm, 60 mm for sloped and funnel nozzles, length 0,5 m. with connectors.
0F07	Easy-Click 60 flexible Extraction arm, 60 mm for sloped and funnel nozzles, length 0,7 m. with connectors.
0F10	Easy-Click 60 flexible Extraction arm, 60 mm for sloped and funnel nozzles, length 1 m
0F15	Extraction arm, flexible, 60 mm for sloped and funnel nozzles, length 1,5 m
0F20	Extraction arm, flexible, 60 mm for sloped and funnel nozzles, length 2,0 m



Accessories for extraction arms

Extraction Arm Nozzles

	Order No.	Description
	ALFA	Easy- Click 60 Funnel nozzle , for flexible and stativ extraction arm, width 230 mm, height 100 mm. To be mounted on an aluminium extraction arm without flexible hose, adapter Z is needed. See extraction arms accessories.
	ALFA-T	Easy- Click 60 Funnel nozzle transparent , for flexible and stativ extraction arm, width 230 mm, height 100 mm. To be mounted on an aluminium extraction arm without flexible hose, adapter Z is needed. See extraction arms accessories.
	Order No.	Description
	FT-N	Easy-Click 60 metal sloped nozzle Ø 50mm, length 130 mm.
	FT-NL	Easy -Click 60 metal metal nozzle Ø 60mm, length 130 mm.
	FT-NS	Easy -Click 60 sloped metal nozzle for with grid Ø 50 mm, length 130 mm.
	FT-P	Easy-Click 60 Sloped nozzle 45° DM, 50 mm length adjustable 105-235 mm and Aluminium extraction arms.
	T005 87 628 34	Sloped aluminium nozzle for 32 mm flex arms, Ø 31 mm, length 60 mm
	FT-U	Easy-Click 60 Funnel nozzle , for flexible and stativ extraction arm, width 190 mm, height 100 mm. To be mounted on an aluminium extraction arm without flexible hose, adapter Z is needed. See extraction arms accessories.
	T005 87 358 45	Exhaust hood, metal

Volume extraction

Tip extraction



Laser extraction

Accessories volume extraction

Spare filter



Accessories for volume extraction

	Order No.	Description
	700-3026	Cleaning Brush with Ø 60 mm flexible arms
	T005 87 627 67	Hose connector, straight for WFE 2S / WFE 4S, Zero Smog 4V / Zero Smog 6V and pre filter box
	T005 87 627 69	Hose connector, angle 90° for WFE 2S / WFE 4S, Zero Smog 4V / Zero Smog 6V and pre filter box







Extraction Hose



Order No.	Description
700-3040-ESD	Easy Click 60 Extraction hose Ø 60 mm length: 1 meter
700-3041-ESD	Easy Click 60 Extraction hose Ø 60 mm length: 2 meter
700-3051-ESD	Easy Click 60 Extraction hose Ø 60 mm length: 3 meter
700-3053-ESD	Easy Click 60 Extraction hose Ø 60 mm length: 5 meter



Easy-Click 60

	Order No.	Description
	T005 87 627 55	Male adapter for hose extension, 60 mm
	T005 87 627 72	Female adapter for installation e.g. stop valve on fume extraction units
	T005 87 627 73	Easy-Click 60 male adapter 90°
	T005 87 620 36	Extension hose, heavy construction, sold by metre (max. length 15m)
	T005 87 627 68	Hose connection 60 mm for flexible hose, sold by the metre T0058762036
	300-3011	Easy-Click 60 hose connection female 60 mm
		

Volume extraction

Tip extraction





Laser extraction

Accessories volume extraction





Spare filter



Pipe system 50

	Order No.	Description
	T005 87 358 47	Hose connection 50 for WFE 2S, WFE 4S, ZS 4V and ZS 6V. For connection to Ø 50 mm (1.96 in) pipe or extraction hose
	T005 87 358 48	Hose connection 50, 90° for connection to Ø 50 mm (1.96 in) pipe or extraction hose
	T005 87 353 27	Extraction hose 50, for connection to pie system Ø 50, sold by meter
 	T005 87 358 79	Hose clamps Ø 50-70 mm, 2 pieces, for securing extraction hose 50 mm

Pipe system 75

	Order No.	Description
	T005 87 358 32	Hose connection 75 for ZS 4V, ZS 6V, WFE 2S und WFE 4S e.g. for connection to a stand alone system by means Ø 75 mm (2.95 in) pipe or extraction hose. Plastic, black
	T005 87 358 33	Hose connection 75, 90° for connection of Ø 75 mm (2.95 in) pipe or extraction hose
	T005 87 353 13	Extraction hose 75 for connection to pie system 75, flexible, sold by metre
	T005 87 358 31	Hose clamps 70-90 mm (2.75 - 3.54 in), 2 pieces, for securing extraction hose 75



Accessories Volume Extraction

	Order No.	Description
	800-5001	Connection hose aluminium coated ø 100 mm, by meter (max lenght 6 m/pc)
	800-5002	Reduzierung 100 / 63 mm, inklusive Schnellverbindungsadapter
	800-5012	Reduzierung 160 / 100 mm
	800-5011-ESD	Connection hose aluminium coated ø 160 mm, by meter (max lenght 6 m/pc)
	800-5004	Reduzierung 80 / 63 mm, inklusive Schnellverbindungsadapter
	T005 36 574 99	Easy-Click 60 Stop valve for table connection of and flex arm and extraction hose including air flow valve and 2 bench mounting brackets.
	T005 36 575 99	Bench mounting brackets, 2 pcs. Maximum width of clamp 100 mm (3.93 in),
	T005 87 627 46	Easy-Click WFV 60 A Automatic valve including 2 bench mounting brackets, WX soldering station controlled automatic valve, male / male
	10072	WFV 60 Stop valve for extraction arms without valve
	780-3001-ESD	Hanging device for table mounting for fume extraction unit WFE 2X, MG 100, MP 140 including 2 brackets
	FT-W	Replacement butterfly valve plate for stop valve with axis rod and handle
	T005 87 628 08	Butterfly valve for WFV 60 stop valve

Volume extraction

Tip extraction













Laser extraction

Accessories volume extraction

Spare filter









Accessories Installation Volume Extraction

	Order No.	Description
 	T005 87 627 66	Easy-Click 60 T-piece with 2 male connections and 1 female connection
 	T005 87 627 74	End cap Ø 60 mm click connections
 	T005 87 627 71	Adapter Ø 75 mm for Easy-Click 60
 	FT910 00 015	Adapter Ø 75 mm to Ø 60 mm
 	T005 87 627 50	40/60 Adapter for Easy-Click 60 Extraction arms on Ø 50 mm WFEMP50 power socket.
 	T005 87 627 53	Hose adapter for WFE 2ES with Silicon Ring Ø 50 mm, for connection of Easy-Click 60 mm extraction hose.



Pipe system 70, Volume extraction

	Order No.	Description
	T005 87 358 70	Pipe 2m, with seal at one end, plastic, PEHD black
	T005 87 358 69	Right angle pipe, 90°, 0,2 m, with seal at one end, plastic, PEHD black
	T005 87 358 71	T-piece, 2 x 90°, 0,5 m , with 3 seals, plastic, PEHD black
	T005 87 358 55	End seal, PE, transparent
	T005 87 358 64	Pipe clamps for pipe system 75, PE, grey
	T005 87 358 63	Adapter PEHD pipe system 75 to pipe system 50, with 2 seals
	T005 87 358 56	Adapter PEHD pipe system 75 to pipe system 50, without seals

Volume extraction

Tip extraction

Laser extraction

Accessories volume extraction

Spare filter



Tip extraction

Weller FE (Fume Extraction) soldering irons have a smoke tube adapted to the handle. When soldering the tube is positioned directly above the tip and collects any fumes produced. Fume extraction irons can be connected to Weller FE.



WFE Fume extraction unit

WFE fume extraction unit 230 V / 50 Hz

6 bar  < 39 db (A) 

Order No. T005 36 402 99

- Maintenance free compressed air converter
- For industrial long term use
- Up to 2 FE soldering irons can be connected
- High stability against overturning
- A compressed air cleaning filter removes additional odours caused by the compressed air.



TECHNICAL DATA

Max. capacity	2 workplaces
Dimensions W x D x H (inch)	5,51 x 5,51 x 7,87
Dimensions W x D x H (mm)	140 x 140 x 200
Weight (ca) in kg	2.7
Noise level (distance 1 m) dB(A)	< 39
Max Turbine Vacuum (Pa)	20.000
Operating pressure	3,5 - 6,0 / 50 - 90
Air consumption l/min	30
Pre filter	Pre filter mat class F7
Compact filter	Particle filter H13, Wide band gas filter (50 % Active carbon + 50 % Chemisorb)
ESD-safe	✓

Scope of supply	Order No.	Model	Description
		WFE Unit	WFE Unit
	T005 36 410 99	Compact filter - WFE, WFE P, WFE 2P, FT 12, FT11, FE 4000	Compact filter - WFE, WFE P, WFE 2P, FT 12, FT11, FE 4000
	T005 36 421 99	Fine dust filter F 7 for WFE, WFE P, WFE 2P, FT 11, FT 12, FE 3000/4000	Fine dust filter F 7
	T005 87 357 57	Air cleaning filter WFE	Compressed air cleaning filter for WFE



WFE P Extraction unit

WFE P fume extraction unit 230 V / 50 Hz

70 W LOW SOUND LEVEL **< 45 db(A)**

Order No. T005 36 386 99

- Up to 2 FE soldering irons can be connected
- Electric vacuum pump to produce the required vacuum
- 2 power stages for higher extraction performance with 2 FE soldering irons
- Portable unit for stand alone applications (Not useable for 24 hours long term use)
- The motor is maintenance-free and has a thermal over load to protect the unit.



TECHNICAL DATA

Max. capacity	1-2 workplaces
Dimensions W x D x H (inch)	5,51 x 5,51 x 11,61
Dimensions W x D x H (mm)	140 x 140 x 295
Weight (ca) in kg	4
Noise level (distance 1 m) dB(A)	< 45
Max Turbine Vacum (Pa)	30.000
Operating pressure	na
Air consumption l/min	na
Pre filter	Pre filter mat class F7
Compact filter	Particle filter H13 Wide band gas filter (50 % Active carbon + 50 % Chemisorb)
ESD-safe	✓

Scope of supply	Order No.	Model	Description
		WFE Unit	WFE Unit
	T005 36 410 99	Compact filter - WFE, WFE P, WFE 2P, FT 12, FT11, FE 4000	Compact filter - WFE, WFE P, WFE 2P, FT 12, FT11, FE 4000
	T005 36 421 99	Fine dust filter F 7 for WFE, WFE P, WFE 2P, FT 11, FT 12, FE 3000/4000	Fine dust filter F 7

Volume extraction

Tip extraction

Laser extraction

Accessories volume extraction

Spare filter



Tip extraction

FT 12 Fume extraxtion unit

Fume extraxtion unit

6 bar **LOW SOUND LEVEL < 37 db (A)**

Order No. 112- 00 00- ESD

- Up to 2 FE soldering irons can be connected
- Maintenance-free compressed air converter
- Portable unit for stand alone applications for industrial long terme use
- For industrial long terme use
- A compressed air cleaning filter removes additional odours caused by the compressed air.



TECHNICAL DATA

Max. capacity	1-2 workplaces
Dimensions W x D x H (inch)	4,73 x 4,73 x 7,87
Dimensions W x D x H (mm)	120 x 120 x 200
Weight (ca) in kg	1.7
Noise level (distance 1 m) dB(A)	< 37
Max Turbine Vacum (Pa)	20.000
Operating pressure	3,5 - 7,0 / 50 - 100
Air consumption l/min	27
Pre filter	Pre filter mat class F7
Compact filter	Particle filter H13, Wide band gas filter (50 % Active carbon + 50 % Chemisorb)
ESD-safe	✓

Scope of supply	Order No.	Model	Description
		FT 12 Unit	FT 12 Unit
	T005 36 410 99	Compact filter - WFE, WFE P, WFE 2P, FT 12, FT11, FE 4000	Compact filter - WFE, WFE P, WFE 2P, FT 12, FT11, FE 4000
	T005 36 421 99	Fine dust filter F 7 for WFE, WFE P, WFE 2P, FT 11, FT 12, FE 3000/4000	Fine dust filter F 7



Zero Smog 20T

ZS 20T fume extraction unit 230 V / 50 Hz



Order No. T005 36 706 99

- Up to 20 FE soldering irons can be connected
- Electric driven, maintenance free turbine produces the required vacuum
- Mobile unit for central and stand alone applications
- Central installation for 50 mm pipe systems up to 200 m (656 ft.) length possible.
- For use with pipe systems up to 200 m (7874 in)



TECHNICAL DATA

Max. capacity	1-20 workplaces
Dimensions W x D x H (inch)	17,7 x 17,7 x 27,3
Dimensions W x D x H (mm)	450 x 450 x 695
Weight (ca) in kg	45
Voltage	230 V (50/60 Hz)
Heating output	530 VA
Noise level (distance 1 m) dB(A)	< 51
Max Turbine Vacum (Pa)	10.000
Capacity m ³ /h	100
Pre filter	Pre filter mat class F7
Compact filter	Particle filter H13 and wide band gas filter (50 % active carbon / 50 % Chemisorb)
ESD-safe	✓
Traceability (unit data)	

Scope of supply	Order No.	Model	Description
	T005 87 358 36	Fine dust filter F7 for Zero Smog 20T, WFE 20D, WFE 4S, Zero Smog 6V, FC 800	Fine dust filter F7 for Zero Smog 20T, WFE 20D, WFE 4S, Zero Smog 6V, FC 800
	T005 87 358 38	Compact filter - WFE 20D, WFE 4S, Zero Smog 6V, Zero Smog 20T, FC 800	Compact filter for WFE 20D, WFE 4S, Zero Smog 6V, Zero Smog 20T, FC 800

Volume extraction

Tip extraction

Laser extraction

Accessories volume extraction

Spare filter



Tip extraction accessories

FE 75 Set



Soldering iron FE 75 with safety rest

80 W Silver Line

Order No. T005 33 151 99

- For tip extraction
- For use with LT tips



Scope of supply	Order No.	Model	Description
	T005 15 020 99	KH 20	Safety Rest for FE 75, TCPS, W 101, LR 21
	T005 29 166 99	FE 75	Soldering iron FE 75
	T005 44 405 99	LT B	Soldering tip, chisel, Ø 2,4 x 0,8 mm
Accessories	Order No.	Model	Description
	T005 87 447 10	Barrel for WSP 80	Barrel for WSP 80 spare part

FE attachment

	Order No.	Description
 	T005 25 125 99	Fume extraction accessory set for LR 21, LR 82, TCPS, W 61, W 101, WSP 150, WP 200, WXP 200 only with safety rest AK 1
	T005 28 126 99	FE Attachment for WSF 80D5/D8 for AKS safety rest
	T005 13 125 99	FE Attachment for DS 22, DS 80 and DSX 80 desoldering iron



Universal FE attachments

		Order No.	Description
		T005 29 186 99	FE Attachment with tube, Ø 6,5 mm for WMP, WSP 80, WP 80, MLR 21, WP 120
		T005 29 214 99	FE attachment with tube Ø 6,5 mm for WXP 65/WP 65 and WXP 120/WP 120 soldering irons
		T005 29 185 99	FE Attachment with tube, Ø 4,5 mm, for WP 80, WSP 80, WMP, WMRP/WXMP, MLR 80
 		T005 87 448 75	FE-Clip-Set for FE-attachment Ø 4,5 mm
 		T005 87 448 76	FE-Clip-Set for FE attachment Ø 6,0 mm
		T005 87 657 98N	FE-Add-on kit, attachment tube Ø 6,5 mm WXP 120
		T005 87 657 99N	FE-Add-on kit, attachment tube Ø 6,5 mm WXP 65

Volume extraction

Tip extraction

Laser extraction

Accessories volume extraction

Spare filter



Tip Extraction Accessories

Order No.	Description
001-0043-ESD	Clip-on kit universal (model 3) for soldering irons from ERSA, Hakko, Weller, Metcal etc.
001-0044-ESD	Clip-on kit universal (model 4), für ERSA Micro-Tool
001-0051-ESD	Clip-on kit for ERSA Micro tool
001-0093	Clip-on kit Weller WSP 80, MRL21, MT1500, Hakko 807/912
010-2825-ESD	Spot suction nozzle for clip-on kit, Metcal/Universal 1, Length: 200mm; Ø5, 0 / 4, 6mm (Length: 7, 874; Ø0, 197 / 0, 181 in)
010-2827-ESD	Spot suction nozzle for clip-on kit, ERSA Micro tool, Length: 140mm; Ø5, 0 / 4, 6mm (Length: 5, 512; Ø0, 197 / 0, 181 in)
010-2828-ESD	Spot suction nozzle for clip-on kit, Filtronic universal 2 &3, Length: 220mm; Ø5, 0 / 4, 6mm (Length: 8, 661; Ø0, 197 / 0, 181 in)
010-2833-ESD	Spot suction nozzle for clip-on kit, Pace PS80/SP2A, Length: 220mm; Ø4, 5 / 3, 9mm (Length: 8, 661; Ø0, 177 / 0, 154 in)
010-2834-ESD	Spot suction nozzle for clip-on kit, Weller WSP80, MLR21, MT1500, Hakko 907/912, Length: 180mm; Ø6, 3 / 5, 4mm (Length: 7, 087; Ø0, 248 / 0, 213 in)
FT-001-0001	E-clips 6/8 mm (0, 029 in)
001-0014	E-clips 4/6 mm (0, 026 in)
010-1041	Conductive silicone hose Ø 7 / 4, 5mm (0, 276 / 0, 177 in), by meter
010-1042	Conductive silicone hose Ø 8 / 5mm (0, 315 / 0, 197 in), by meter
010-9901-ESD	Cleaning brush, 4mm (0, 157 in)
010-9902-ESD	Cleaning brush, 5mm (0, 197 in)

Locking clip for extraction hose

Order No.	Description
T005 36 352 99	Locking clip for extraction hose
T005 25 410 00	Extraction hose (spare), Ø 5 mm, by meter





Accessories for workbench installations

	Order No.	Description
 	T005 36 316 99	Extraction hose complete with 2 connecting elements for direct connection of unit Zero Smog 20T (WFE 20D) to pipe system 50
 	T005 36 414 00	Extraction hose without connecting elements, sold by metre
 	T005 36 415 99	Connection Element 40-50 for connecting extraction hose 40 and pipe system 50
 	T005 36 326 99	Extension hose DN 17, 5 m
 	T005 87 358 65	Connection nipple on extension hose DN 17 / G 3/8" (T0053632699)
 	T005 36 338 99	Connection nipple for extraction hose Ø 5 mm / 0.19 in, for connection with FE soldering irons to nossible 50
 	T005 87 350 50	End cap for connection nipple Ø 5 mm (T0053633899)
 	T055 87 628 10	Connection adapter for Zero Smog 20T

Volume extraction

Tip extraction







Laser extraction

Accessories volume extraction



Spare filter



Accessories Tip Extraction







	Order No.	Description
	T005 15 086 99	Basic Unit pneumatic (for WFE, WFE P) Stop+Go + Safety Rest with Fibre Optic Sensor for FE 75
	T005 15 076 99	Basic Unit Electric (for WFE, WFE P) Stop+Go + Safety Rest Function with Fibre Optic Sensor for FE 75
	T005 15 080 99	Second Safety Rest with Fibre Optic Sensor for Extending to 2 Workplaces for FE 75
	T005 15 168 99	Basic unit electric (for WFE) safety rest with Stop+Go function with fibre optic sensor for WSP 80, WP 80, WP 120
	T005 15 167 99	Basic unit electric (for WFE P) safety rest with Stop+Go function for soldering irons WSP 80, WP 80, WP 120 with fibre optic sensor.
	T005 15 161 72	WDH 10T OPTO Second safety rest for KHE / KHP with fibre optic sensor for extending to 2 workplaces
	T005 15 152 99	Safety rest with dry cleaner

Cord Support

	Order No.	Description
 	T005 15 066 99	Cord support for safety rest KH 20/23



Pipe System 50 - Tip extraction

	Order No.	Description
	T005 36 323 99	Pipe 2 m, with seal at one end, plastic, PEHD black
	T005 36 322 99	Right angle pipe 90°, 0,2 m, with seal at one end, PEHD black
	T005 36 344 99	T-piece 2 x 90°, 0,5 m, with 3 seals, plastic, PEHD black
	T005 36 321 99	Branch, 2 x 45°, 0,3 m, with 2 seals, plastic, PEHD black
	T005 36 319 99	Double socket for DN 50, PEHD, black
	T005 36 324 99	End seal for DN 50, transparent
	T005 36 329 99	Pipe clamps for 50 pipe system, grey, e.g. wall mount

Volume extraction

Tip extraction

Laser extraction

Accessories volume extraction

Spare filter



Laser extraction

Weller offers with its Laserline series mobile fume extractions for all kinds of laser applications. All systems are retrofitable with special filters for cleanroom or for the use of inkjet printers. Weller Laserline filter systems have one more crucial advantage. they are the quietest in the world.

Laser Line LL 150

Laser extraction unit, 100- 240 V / 60 Hz

175 VA

LOW SOUND LEVEL  < 50 db(A)



Order No. FT-L15

- Remote control via RS 232 port
- Efficient laser extraction unit for low dust amount
- Optical and acoustic filter full alarm
- Switch power supply 100 - 240 V
- 3 levels of filtering



TECHNICAL DATA

Dimensions W x D x H (inch)	13,4 x 13,4 x 24,01
Dimensions W x D x H (mm)	340 x 340 x 640
Weight	18 kg
Voltage	100 - 240 V, 60 Hz
Heating output	175 VA
Noise level (distance 1 m) dB(A)	< 50 dB (A)
Max. vacuum	2300 Pa
Capacity l/min	140 m ³ / h
Max. extraction performance with standard filter, m3/h /CFM)	100 (58,8)
HEPA Class Micro Filter, separation degree, MPPS %	> 99,95
Active Carbon Gasfilter Chemisorption, separation degree, %	> 99,96
Pre-filter (class/surface m2)	F8 / 0,24

Scope of supply	Order No.	Model	Description
		Laser Line 150 Unit	Laser Fume Extraction Unit 150
	150-2012-L	Micro/Gasfilter Laser Line 150	Micro/Gasfilter Laser Line 150 . Particle filter H13 , Wide band gas filter (50 % active carbon + 50 % Chemisorb)
	150-4000	Pre-filter F7 Laser Line 150	Pre-filter F7 Laser Line 150



Laser Line LL 200V

Laser extraction unit, 230V / 50 Hz

200 VA

LOW SOUND LEVEL

< 52 db(A)



Order No. FT91 00 169 9

- For Laser marking, engraving, and welding applications with low up to mid dust volumes.
- The Constant flow control (CFC) guarantees a automatical air flow regulation independent of the filter pollution rate.
- Efficiency test via USB port
- Acoustical and optical filter alarm
- Low noise level

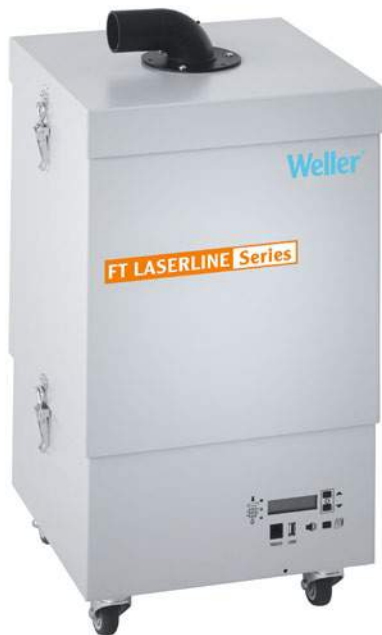

TECHNICAL DATA

Dimensions W x D x H (inch)	12,59 x 12,59 x 27,55
Dimensions W x D x H (mm)	320 x 320 x 700
Weight	21 kg
Voltage	230 V, 50/60 Hz
Heating output	200 VA
Noise level (distance 1 m) dB(A)	< 52 dB (A)
Max. vacuum	2700 Pa
Capacity l/min	230 m ³ / h
Max. extraction performance with standard filter, m3/h /CFM)	160 (95)
HEPA Class Micro Filter, separation degree, MPPS %	> 99,95
Active Carbon Gasfilter Chemisorption, separation degree, %	> 99,96
Pre-filter (class/surface m2)	F7 / 0,45

Scope of supply

Order No.	Model	Description
	Laser Line 200V Unit	Laser Fume Extraction Unit 200V
FT910 00 007	Pocket filter F7 0,5 m2 Laser Line 200V	Pocket filter F 7 Filter Surface 0, 5 m2 for Laser Line 200V
FT910 00 008	Compact filter for Laser Line 200 V	Particle filter H13 and Wide band gas filter

Volume extraction

Tip extraction

Laser extraction

Accessories volume extraction

Spare filter



Laser extraction

Laser Line 400V

Laser extraction unit, 230V / 50 Hz

460 VA

LOW SOUND LEVEL  < 53 db(A)



Order No. FT91 00 269 9

- The Constant flow control (CFC) guarantees a optimal air flow regulation independent of the filter pollution rate.
- Efficiency test via USB port
- Electronic filter control with optical and acoustical filter alarm
- Laser extraction unit for laser marking, grinding, cutting , welding with high dust amount.



TECHNICAL DATA

Dimensions W x D x H (inch)	17,4 x 17,4 x 40,1
Dimensions W x D x H (mm)	441 x 441 x 1020
Weight	
Voltage	230 V, 50/60 Hz
Heating output	460 VA
Noise level (distance 1 m) dB(A)	< 53 dB (A)
Max. vacuum	3000 Pa
Capacity l/min	645 m ³ / h
Max. extraction performance with standard filter, m3/h /CFM)	400 (235)
HEPA Class Micro Filter, separation degree, MPPS %	> 99,95
Active Carbon Gasfilter Chemisorption, separation degree, %	> 99,96
Pre-filter (class/surface m2)	F7 / 2,0

Scope of supply	Order No.	Model	Description
		Laser Line 400V Unit	Laser Line 400V Unit
	FT910 00 006	Pocket filter F7 2,5 m2 Laser Line 400V	Pocket filter F 7 Filter Surface 2, 5 m2 for Laser Line 400V
	FT910 00 010	Compact Filter Laser Line 400V	Partikelfilter H13, Gasfilter (50 % Aktivkohle / 50 % Chemisorb)



Accessories

Exhaust accessories to blow waste air out of a building



Order No.	Description
T005 87 358 40	Exhaust connector DN 100 for Zero Smog 6V and WFE 4S
T005 87 359 20	Exhaust connector of pipe 100 to fume extraction unit WFE 20D, ZS 20 T
T005 87 359 15	Exhaust connector DN 75 for WFE 2S, Zero Smog 4V, WFE 4S and Zero Smog 6V

Remote control for fume extraction units

Order No.	Description	Order No.	Description
 	T005 87 359 09 Remote control for fume extraction units WFE 20D, WFE 2S, WFE 4S, WFE 8S, ZS 4V, ZS 6V, ZS 20T with filter status display		T005 87 647 12 WX Adapter for WFE/WHP
	T005 31 191 99 Interface cable RS 232, 2 m (78.74 in) for remote control or monitoring by PC (type 1:1) T005 87 359 09		T005 87 647 10 WX Connecting cable, 2 m
 	700-3057 Remote control for fume extraction unit WFE 2X, MG 100, MG 200, MG 400 with 2 m (78.74 in) cable		T005 87 647 26 WX HUB
 	T005 87 627 24 WX Adapter is needed for connection of the remote control (T0058735909) to Zero Smog 4V, 6V, 20T		T005 87 687 67 WT HUB

Volume extraction

Tip extraction

Laser extraction

Accessories volume extraction

Spare filter





Weller Zero-Smog® systems

Specifically designed for continuous operation in industrial environments. Care and attention at the design stage plus careful component choice and a high quality manufacturing process have given Weller extraction systems a world wide reputation for reliability and longevity.

Weller Zero-Smog® fume extraction

Weller Zero-Smog® systems have a three stage filter system (excl. MG 100S) for removing small particles, fumes and gases that are produced in different working processes:
 The hazardous substances are efficiently captured by the nozzle and are absorbed into the filter.
 Bigger particles get caught in the pre-filter and smaller particles get caught in the HEPA (High Efficiency Particulate Air) filter.
 The wide band gas filter removes fumes and adhesives.
 End product – clean air – is re-circulated into the workplace.

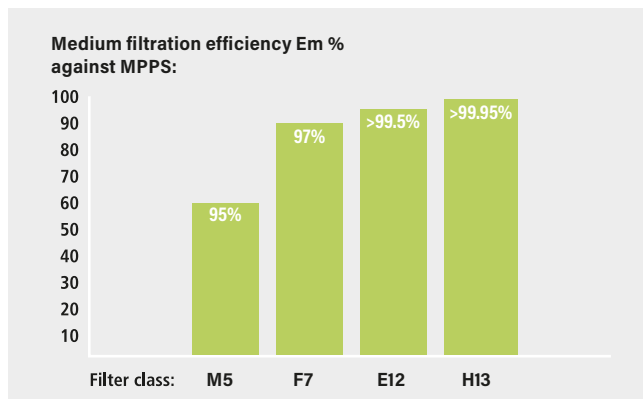
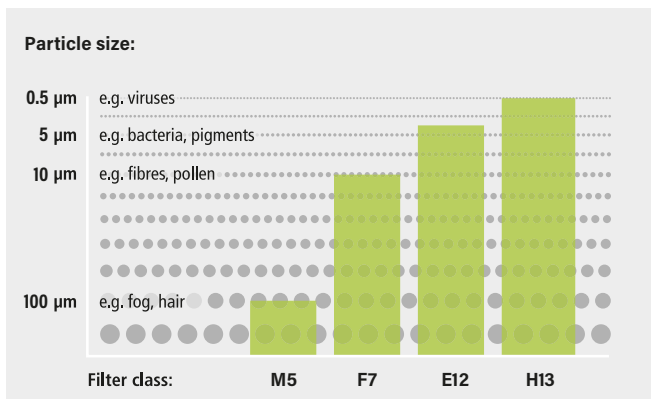

Filter Class M5, F7: Fine dust filter as per EN 779:2012
 Filter Class E12/H13: According EN 1822:2009 HEPA (High Efficiency Particulate Air) Filter

Filter classification according EN norm EN 1822:2009

Filter Class	Recommended Application
M5	For standard applications
F7	For applications with high flux or dust content
E12 / H13	For applications with high flux or dust content
Gas	For applications with fumes from adhesives and solvents

Group	Filter class	Integral value	
		Degree of separation	Transmittance degree
EPA	E10	85 %	15 %
	E11	95 %	5 %
	E12	99,5 %	0,5 %
HEPA	H13	99,95 %	0,05 %
	H14	99,995 %	0,005 %

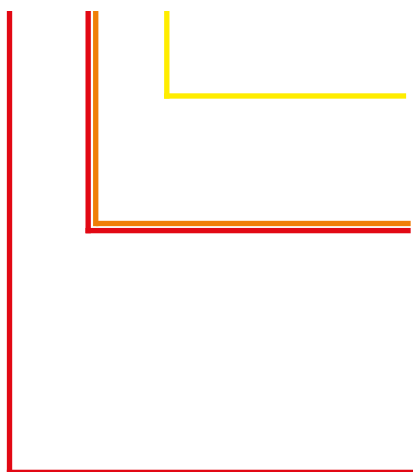

1. Medium / fine dust filter

For standard applications with a small amount of flux and pollution gases with high solid content, Weller offers filter classes M5 or F7

2. Compact filter consisting of:

Particle filter H13 with deposition performance according EN 1822:2009
 > 99.955% in MPPS (particles 0.16 µm)
 > 99.994% particles 0.3 µm
 Wide band gas filter. For cleaning harmful fumes and vapours. The Weller wide band gas filter consists of 50% active carbon and 50% Chemisorb (potassium permanganate). Harmful gases with a high molecular weight are cleaned by the active carbon. Chemisorb is suitable for absorbing gases of lower molecular weight. Because of its composition, Chemisorb is able to convert a large number of chemical pollutants (e.g. formaldehyde) into non-polluting gases by means of molecular modification.

3. Gas filter (optional)

The gas filter is used for extracting adhesive fumes and solvents. Experience has shown that filtering suspended particles is not so vital in this respect. The gas filter is filled with 50% active carbon and 50% Chemisorb. The particle filter is omitted.



Filter Matrix

Zero Smog 2, MG 130, MG 140 ,
Zero Smog 4V, Zero Smog 6V,
Zero Smog 20T,
Zero Smog TL, Zero Smog EL

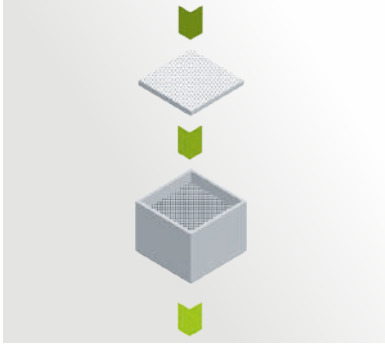

MG 100S

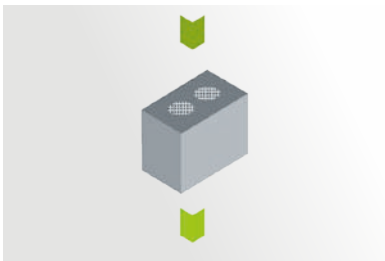

FT 12, WFE P

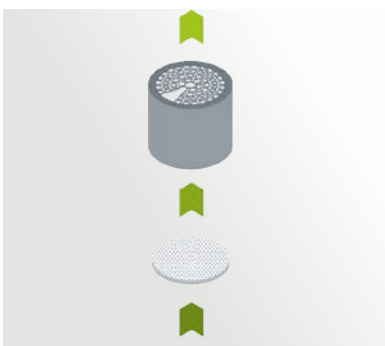

Filter



Zero Smog TL	FT91013699	
Zero Smog EL		
MG 130	100-240 V: 130-1000-ESD	
MG 100S	230 V: 100-1000-ESD	120 V (USA): U-100-1000-ESD
MG 140	230 V: 145-1000-ESD	230 V: mit 145-1002-ESD
Zero Smog 4V	230 V: T005 36 606 99	100-120 V (USA): T005 36 602 99
Zero Smog 4V gas filter	230 V: T005 36 616 99	100-120 V (USA): T005 36 612 99
Zero Smog 6V	230 V: T005 36 666 99	100-120 V (USA): T005 36 662 99
Zero Smog 6V	230 V: T005 36 676 99	100-120 V (USA): T005 36 672 99
WFE		
WFEP	230 V: T005 36 386 99	120 V, WFE2P (USA): T005 36 232 99
FT 12		
Zero Smog 20T	230 V: T005 36 706 99	120 V (USA): T005 36 702 99
Pocket filter ZS6V/4V	T005 87 358 62	

Special filter

MG 100S	230 V: 100-1000-ESD	120 V (USA): U-100-1000-ESD
MG 140	230 V: 145-1000-ESD	230 V: mit 145-1002-ESD
Zero Smog 4V	230 V: T005 36 606 99	100-120 V (USA): T005 36 602 99
Zero Smog 6V	230 V: T005 36 666 99	100-120 V (USA): T005 36 662 99
WFE		
WFEP	230 V: T005 36 386 99	120 V, WFE2P (USA): T005 36 232 99
FT 12		



Spare filter

Compressed air cleaning filter for WFE, FT 12, FT 12-PF

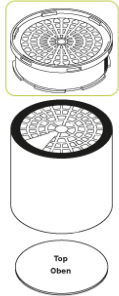

Order No.	Description	Filter type	PU
T005 87 357 57	Compressed air cleaning filter for WFE	Active carbon 100%	1
210-0323-ESD	Compressed air cleaning filter for FT 1 / FT 12 / FT 13	Active carbon 100%	1
210-0310	Compressed air cleaning filter for FT 12 (Model 93)	Active carbon 100%	1

Compact filter - WFE, WFE P, WFE 2P, FT 12, FT11, FE 4000



Order No.	Description	Filter type	PU
T005 36 410 99	Compact filter - WFE, WFE P, WFE 2P, FT 12, FT11, FE 4000	Particle filter H13, Wide band gas filter (50 % active carbon + 50 % Chemisorb)	1
212-5001-ESD	Main filter FT 12-PF		1

Compactfilter glueing application WFE, WFE P, WFE 2P, FT 12, FT11, FE 4000

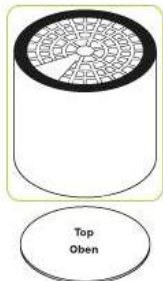

Order No.	Description	Filter type	PU
T005 36 407 99	Compactfilter glueing application	Compact filter H13, wide band gas filter 100% active carbon	1
212-4012-ESD	Main filter FE 3000		1



Compressed air cleaning filter for WFE, WFE P, WFE2P, FT 11, FT 12, FT 12-PF, FE 3000/4000



Order No.	Description	Filter type	PU
T005 36 421 99	Fine dust filter F 7	Fine dust filter F7	3

Compressed air cleaning filter for WFE, WFE P, WFE2P, FT 12, FT 12-PF

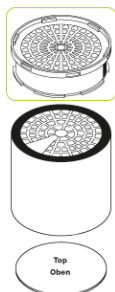

Order No.	Description	Filter type	PU
210-0323-ESD	Compressed air cleaning filter for FT 1 / FT 12 / FT 13	Active carbon 100%	1
211-0011-ESD	Top filter FT 1		1
210-0315	Filter discs FT 1 (pink)		10

Medium dust filter M5

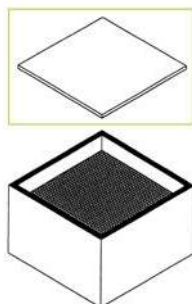

Order No.	Description	Filter type	PU
T005 87 358 37	Fine dust filter M5 for Zero Smog 20T, WFE 20D, WFE 4S, Zero Smog 6V, FC 800	Fine dust filter M5	10
T005 87 359 37	Fine dust filter for WFE 2S, Zero Smog 4V	Fine dust filter M5	10

Fine dust filter F7

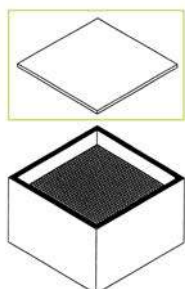

Order No.	Description	Filter type	PU
T005 87 358 36	Fine dust filter F7 for Zero Smog 20T, WFE 20D, WFE 4S, Zero Smog 6V, FC 800	Fine dust filter F7	10
T005 87 359 38	Fine dust filter F7 for WFE 2S, Zero Smog 4V	Fine dust filter F7	10
T005 87 628 57	Fine dust filter F7 for Zero Smog TL, Zero Smog EL, Zero Smog 2, WFE 2ES / 2CS	Fine dust filter F7	10

Volume extraction

Tip extraction

Laser extraction

Accessories volume extraction

Spare filter



Spare filter

Compact filter

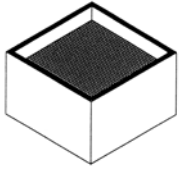

Order No.	Description	Filter type	PU
T005 87 358 38	Compact filter for WFE 20D, WFE 4S, Zero Smog 6V, Zero Smog 20T, FC 800	Particle filter H13 and wide band gas filter (50% active carbon, 50% Chemisorb)	1
T005 87 359 36	Compact filter for Zero Smog 4V, WFE 2S	Particle filter H13 and wide band gas filter (50% active carbon, 50% Chemisorb)	1
T005 87 627 01	Filterset H13 for Zero Smog 2, Zero Smog EL, WFE 2ES / CS	(10% Aktivkohle)	1
T005 87 628 58	Compact filter for ZTL	Particle filter H13 and wide band gas filter (50% active carbon, 50% Chemisorb)	1

Adhesive fume filter

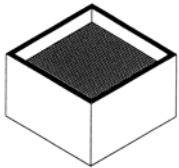

Order No.	Description	Filter type	PU
T005 87 358 35	Wide band gas filter for WFE 4S, Zero Smog 6V, FC 800	Wide band gas filter (50 % active carbon + 50 % Chemisorb)	1
T005 87 358 95	Wide band gas filter for adhesive fumes for Zero Smog 2, Zero Smog 4V, WFE 2ES, WFE 2S	Wide band gas filter (50 % active carbon + 50 % Chemisorb)	1

Pocket filter



Order No.	Description	Filter type	PU
T005 87 358 60	Pocket filter F7 for Zero Smog 4S, Zero Smog 6V, WFE 2S / WFE 4S	Pocket filter F7	1

Pocket filter



Order No.	Description	Filter type	PU
T005 87 359 24	Fleece filter for Zero Smorg 4V, Zero Smog 6V, WFE 2S / WFE 4S		1



Replacement filters for MG filter systems

Compact filter for MG 140

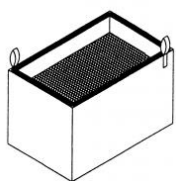

Order No.	Description	Filter type	PU
145-2000-ESD	Particle filter H13 and wide band gas filter, Standard	Particle filter H13 , Wide band gas filter (50 % active carbon + 50 % Chemisorb)	1
145-2002-ESD	Particle filter H13 and wide band gas filter, Cleanroom	Particle filter H13, Wide band gas filter (50 % Active carbon + 50 % Chemisorb)	1
145-2012-ESD	Particle filter H13 and wide band gas filter, Solvent / VOC	Particle filter H13, wide band gas filter (100% active carbon)	1
145-2003-ESD	Particle filter H13 and wide band gas filter, MEK	Particle filter H13, wide band gas filter (100% Chemisorb)	1

Compact filter for MG 100, MG 100S, MG 80S, WFE 2X

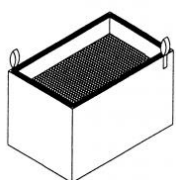

Order No.	Description	Filter type	PU
100-2000-ESD	Particle filter H13 and wide band gas filter, Standard	Particle filter H13 , Wide band gas filter (50 % active carbon + 50 % Chemisorb)	1
100-2012-ESD	Particle filter H13 and wide band gas filter, Solvent / VOC	Particle filter H13, wide band gas filter (100% active carbon)	1
100-2003-ESD	Particle filter H13 and wide band gas filter, MEK	Particle filter H13, wide band gas filter (100% Chemisorb)	1

Compact filter for MG130, Tiger



Order No.	Description	Filter type	PU
130-2000-ESD	Particle filter H13 and wide band gas filter, Standard	Particle filter H13, Wide band gas filter (50 % active carbon + 50 % Chemisorb)	1

Volume extraction

Tip extraction

Laser extraction

Accessories volume extraction

Spare filter



Spare filter

Compact filter for MG 200, MG 400

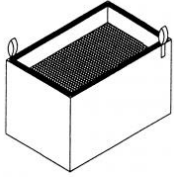

Order No.	Description	Filter type	PU
200-2000-ESD	Compact filter MG 200 Standard	Particle filter H13, Wide band gas filter (50 % active carbon + 50 % Chemisorb)	2
200-2002-ESD	Particle filter H13 and wide band gas filter, cleanroom	Particle filter H13, Wide band gas filter (50 % Active carbon + 50 % Chemisorb)	2
200-2003-ESD	Compact filter for MG 200, MEK	Particle filter H13, wide band gas filter (100% Chemisorb)	2
200-2012-ESD	Particle filter H13 and wide band gas filter, Solvent / VOC	Particle filter H13, wide band gas filter (100% active carbon)	2

Prefilter for MP 140

Order No.	Description	Filter type	PU
140-2000-ESD	Particle filter E 12		1
145-4000	Pre-filter bag F8 MG 140		2
200-4000	Fine dust pocket filter F8 MG 200		2
450-2000	Fine dust pocket filter F8 MG 400		2
130-1000-ESD	Fume extraction unit MG 130		

Prefilter for MP 140, MG100



Order No.	Description	Filter type	PU
PF-100 0	Pre filter box, incl. brackets and 2 m connection hose		1
500-4000	Pre-filter for PF-1000, BT 75		5

Compressed air cleaning filter for WFE, WFE P, WFE2P, FT 12, FT 12-PF



Order No.	Description	Filter type	PU
210-0323-ESD	Compressed air cleaning filter for FT 1 / FT 12 / FT 13	Active carbon 100%	1
210-0310	Compressed air cleaning filter for FT 12 (Model 93)	Active carbon 100%	1
T005 36 421 99	Fine dust filter F 7	Fine dust filter F7	3

Replacement filter CBC-R

Order No.	Description	Filter type	PU
F01	Replacement filter CBC-R		1



Replacement filters for discontinued MG filter systems

Compact filter for MG 75

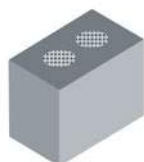

Order No.	Description	Filter type	PU
750-2000-ESD	Particle filter H13 and gas filter, Standard		1
750-2002-ESD	Particle filter H13 and gas filter, Cleanroom		1
750-2003-ESD	Particle filter H13 and gas filter, MEK		1

Compact filter for MG 95

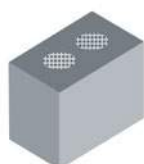

Order No.	Description	Filter type	PU
950-2000-ESD	Particle filter H13 and gas filter, Standard		1
950-2002-ESD	Particle filter H13 and gas filter, Cleanroom		1
950-2003-ESD	Particle filter H13 and gas filter, MEK		1

Pre-filter for PF-1000, BT 75

Order No.	Description	Filter type	PU
500-4000	Pre-filter for PF-1000, BT 75		5

Pre-filter for MG75, MG 95

Order No.	Description	Filter type	PU
750-4100	Replacement filter for pre-filter		5

Volume extraction

Tip extraction

Laser extraction

Accessories volume extraction

Spare filter



Spare filter