

Status: 07/2020



cab product overview

Devices and systems for the electronics production

Types



Off-cut remover **HEKTOR 2**

Page 3

PCB separators **MAESTRO 2, 2M**

Page 4

PCB separator **MAESTRO 3E**

Page 5

PCB separator **MAESTRO 4S**

Pages 6/7

Conveyor belt

PCB separator **MAESTRO 5L**

Page 8

PCB separator **MAESTRO 6**

Pages 9 - 11



PCB magazine **series 100, 180, 300**

Pages 12 - 14

PCB magazine **series 600, 700, 800**

Pages 15 - 20

PCB magazine accessories

Special magazines

Page 21

Off-cut remover HEKTOR 2



Technical data	
Separation method	Punch blade
Operation	manual
Material	FR4
PCB thickness	up to 2.5 mm
Air pressure supply	1/4" coupling socket
Operating pressure, typical	4 bar
Temperature / humidity	Operation + 10 - 35°C / 10 - 85 %
	Stock 0 - 60°C / 20 - 80 %
not condensing	Transport - 25 - 60°C / 20 - 80 %
Width x Height x Depth	220 x 170 x 255 mm
Weight	2.7 kg
Approvals	CE, FCC Class A

PCBs are separated carefully and quickly, off-cuts are removed precisely and smoothly. A two-part matrix enables the different blades to be assembled resp. exchanged easily.

Off-cuts are punched out with the help of a compressed air cylinder. The operating pressure can be set on the unit.

Safe operation

PCBs are positioned with their milled groove over the blade onto the matrix. The off-cut is fed below the punch blade. A foot switch triggers the punching and the off-cut is collected in the bottom tool.

Part no.	Product
8932145	Off-cut remover HEKTOR 2 (no blades)
8932xxx	Blade (to be ordered separately)
Scope of delivery	Off-cut remover with pressure regulator Foot switch Allen key 2 mm Allen key 4 mm Operator's manual DE/EN

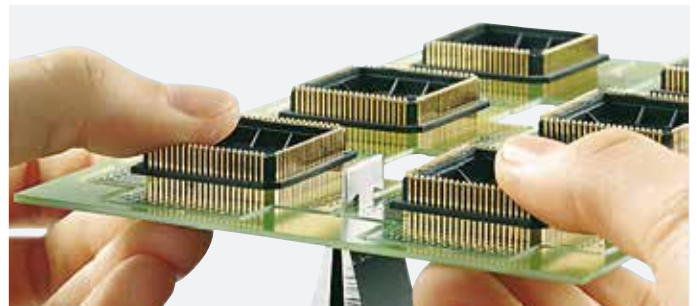

Blade		Milled groove width	Blade width	Blade length	Cutting length	Solder side free of components	Milled groove length	Off-cut width
Part no.		A	B	C	D	E	F	G
8932137.001	Blade 1,5 T	≥ 1.5	1.35	17.2	4.7	> 19	> 19	3
8932138.001	Blade 2,0 T	≥ 2.0	1.85	17.2	5.2	> 19	> 19	3
8932191.001	Blade 2,4 T	≥ 2.4	2.25	18	5.7	> 19	> 19	3
8932139.001	Blade 2,5 T	≥ 2.5	2.35	18	5.7	> 19	> 19	3
8932144.001	Blade 3,0 T	≥ 3.0	2.85	18	5.7	> 19	> 19	2.5
8932122.001	Blade 1,5 L	≥ 1.5	1.35	12	4.7	> 15	> 13	3
8932123.001	Blade 2,0 L	≥ 2.0	1.85	12	5.2	> 15	> 13	3
8932141.001	Blade 2,4 L	≥ 2.4	2.25	12	5.7	> 15	> 13	3
8932124.001	Blade 2,5 L	≥ 2.5	2.35	12	5.7	> 15	> 13	3
8932125.001	Blade 3,0 L	≥ 3.0	2.85	12	5.7	> 15	> 13	2.5
8932171.001	Matrix (as a spare part)							

T blade

to punch out off-cuts on the right and left margins. Turning the PCB is not necessary

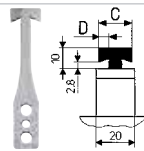

L blade

used with small distances between the off-cuts

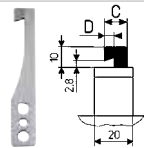

Matrix

included in the scope of delivery



Further blade thicknesses on request

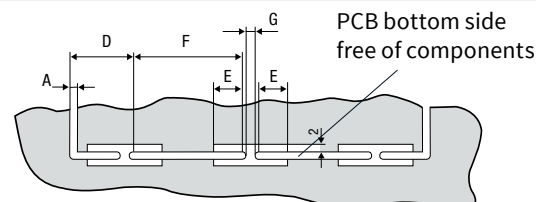

PCB separators MAESTRO 2, 2M



The compact MAESTRO 2 separates PCBs quickly and economically. Little footprint is required.

MAESTRO 2

is the affordable entry-level device to handle smaller demands. PCBs are fed between the circular blades manually to be separated.

MAESTRO 2M, motor-driven

to separate large numbers of PCBs without tiring. The lower circular blade is motor-driven. The PCB is fed, seized by the circular blade, transported and separated. The device especially fits with highly dense assembly or slim margin strips. Three speeds can be selected.

Safe operation

The distance between the holder **1** and the guide **2** is set so the PCB can be fed only in the milled groove.

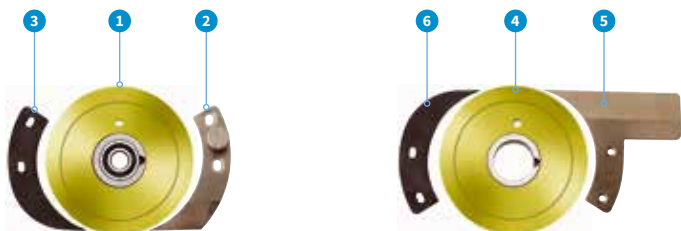

Technical data	MAESTRO 2	MAESTRO 2M
Separation method	Component side	Circular blade
	Solder side	Circular blade
Operation	manual	motor-driven
Separation speed	-	100, 200, 300 mm/s
Separation length	15 - 300 mm	
Material	FR4	
Component height	Solder/component side up to 34 mm	
Power supply	-	230/115 VAC, 50/60 Hz
Temperature / Operation	+ 10 - 35°C / 10 - 85 %	
humidity Stock	0 - 60°C / 20 - 80 %	
not condensing Transport	- 25 - 60°C / 20 - 80 %	
Width x Height x Depth	195 x 330 x 620 mm	
Weight	16 kg	19 kg
Approvals	CE, FCC Class A	

Component height	
Outside dimensions increased after separation: typically 0.2 mm	
The milled groove may be interrupted by cutouts to a length of up to 5 mm.	

Part no.	Product	
8933900	PCB separator MAESTRO 2	
8933935	PCB separator MAESTRO 2M	
Scope of delivery	PCB separator Power cable Type E+F, length 1.8 m (MAESTRO 2M only) Allen key 2 mm Operator's manual DE/EN	
Pos.	Part no.	Wear parts
1	8930509.001	Circular blade FR4
2	8930522.001	Holder
3	8930744.001	Upper blade protection
4	8933661.001	Lower circular blade
5	8930514.001	Guide
6	8930745.001	Lower blade protection

PCB separator MAESTRO 3E



The MAESTRO 3E separates both small and large PCBs. The support table and the rest can be set continuously to the best possible operational position. By adjusting the distance between the linear blade and the rest, margin strips can fall through and are sorted out.

Safe operation

A PCB is positioned with its milled groove onto the linear blade and the circular blade is moved manually through the PCB. The distance between the holder and the linear blade is set so the PCB can be separated only in the milled groove.

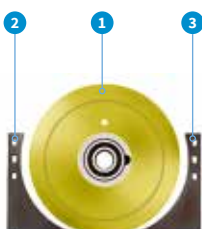

Technical data	
Separation method	Component side Circular blade Solder side Linear blade
Operation	manual
Separation length	up to 450 mm
Material	FR4
Component height	Component side up to 34 mm Solder side up to 23 mm
Temperature / humidity not condensing	Operation + 10 - 35°C / 10 - 85 % Stock 0 - 60°C / 20 - 80 % Transport - 25 - 60°C / 20 - 80 %
Width x Height x Depth	350 x 455 x 700 mm
Weight	22 kg
Approvals	CE, FCC Class A

Component height	
Outside dimensions increased after separation: typically 0.2 mm	
The milled groove may be interrupted by cutouts.	
Protruding components need a recessed linear blade. Contact us, if required	

Part no.	Product	
8933945	PCB separator MAESTRO 3E/450	
Scope of delivery	PCB separator Allen key 2 mm Operator's manual DE/EN	
Pos.	Part no.	Wear parts
1	8930509.001	Circular blade FR4
2	8936615.001	Blade protection
3	8936614.001	Blade protection
4	8933394.001	Linear blade 450

PCB separator MAESTRO 4S



MAESTRO 4S separates both small and large PCBs quickly and economically without stress.

Key features:

- Blade distance to be entered on the operation panel is set motor-driven.
- Up to nine programs to be stored
- Separation length to be continuously adjusted via limit switches
- In terms of a preventive blade maintenance, the cutting performance is displayed.

By traversing the milled groove once, tensile and compressive stresses can cause damage to sensitive components located close to the groove. A second traverse and simultaneous readjustment of the blade distance already reduces stresses considerably. The quality of the assembled PCBs improves significantly.

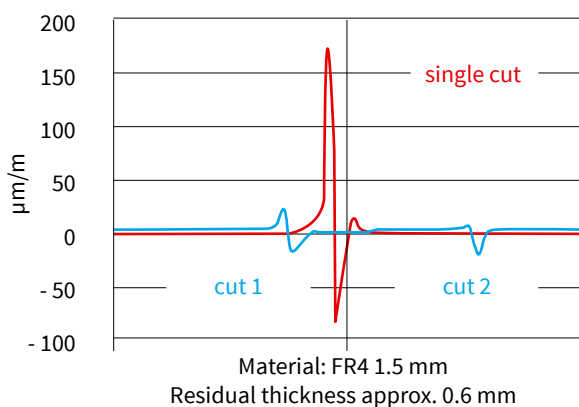

Dial gauge

In order to separate without stress and to achieve a long service life, the circular and linear blades have to be guided along the entire separation. The dial gauge setting and regularly checking the parallelism is assembled to the carriage.



Technical data	4S/450	4S/600
Separation method	Component side Circular blade	Solder side Linear blade
Operation	path-optimized, motor-driven	
Separation speed	300, 500 mm/s, to be switched	
Materials	FR4, aluminum	
Component height	Component/solder side up to 34 mm	
Separation length	up to 450 mm	up to 600 mm
Support table depth	200 mm	
Programming		
Start	Traverse to initial position	
Programs	9	
Separation steps	1 - 5	
Blade distance	0.9 - 0.05 mm	
Key button	Unlock program selection	
Performance display	up to 99 km	
DEL	Step reset	
Power switch	ON/OFF	
Foot switch	START separation	
Safety switch	E-stop	
Power supply	100 - 240 VAC, 50/60 Hz	
Emmission sound pressure level	LpA < 70 dB (A)	
Temperature / Operation	+ 10 - 35°C / 10 - 85 %	
humidity Stock	0 - 60°C / 20 - 80 %	
not condensing Transport	- 25 - 60°C / 20 - 80 %	
Width x Height x Depth	702 x 434 x 425 mm	852 x 434 x 425 mm
Weight	38 kg	46 kg
Approvals	CE, FCC Class A	

Part no.	Product	
8936800	PCB separator MAESTRO 4S/450	
8936800.520	PCB separator MAESTRO 4S/450/alu	
8936745	PCB separator MAESTRO 4S/600	
8936745.520	PCB separator MAESTRO 4S/600/alu	
Scope of delivery	PCB separator Power cable Type E+F, length 1.8 m Foot switch Allen key 2 mm Support table including assembly kit Dial gauge Operator's manual DE/EN	
Pos.	Part no.	Wear parts
1	8930509.001	Circular blade
2	8936615.001	Blade protection
3	8936614.001	Blade protection
4	8933394.001	Linear blade 450
	8933682.001	Linear blade 600

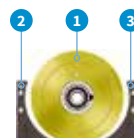

PCB separator MAESTRO 4S

Separating aluminum

To separate aluminum with MAESTRO 4S, special adjustment is needed for the standard circular blade. For information see the operator's manual

Aluminum PCBs are manufactured in various alloys. Sample PCBs added to a request help with adjusting the circular blade and optimizing the cutting geometry.

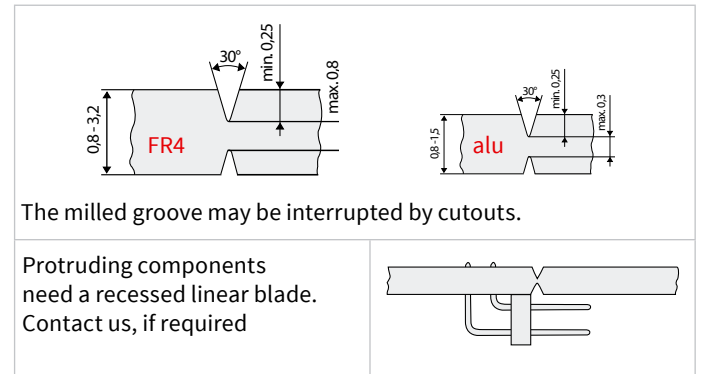
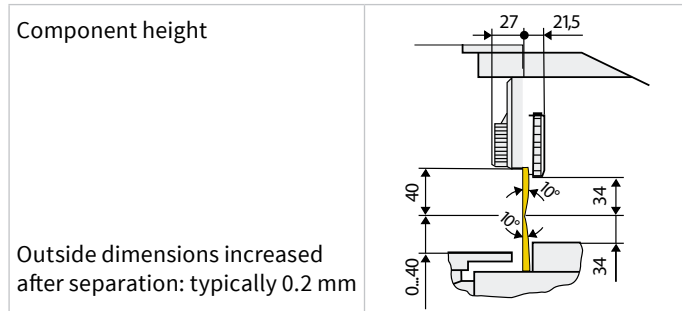

Accessory



Conveyor belt

to deposit separated PCBs individually and further transport them aside. The speed adapts to the size of the PCB. Incoming PCBs are detected by a light barrier and the belt stops.

Technical data	450	600
Conveyor belt material	antistatic	
Direction of movement	to the right	
Belt speed	5, 6, 7, 8, 9 m/min	
Light barrier	to be activated to stop the belt moving	
Vertical distance to the linear blade	5 - 17 mm	
PCB depth	up to 200 mm	
Belt width	170 mm	
Length	1,200 mm	1,350 mm
Power supply	100 - 240 VAC, 50/60 Hz	
Temperature / Operation	+ 10 - 35°C / 10 - 85 %	
humidity Stock	0 - 60°C / 20 - 80 %	
not condensing Transport	- 25 - 60°C / 20 - 80 %	
Weight	14 kg	
Approvals	CE, FCC Class A	

Part no.	Product
8931240	Conveyor belt 450
Lieferumfang	Power cable Type E+F, length 1.8 m Assembly kit Operator's manual DE/EN

PCB separator MAESTRO 5L



It can be used economically when large quantities of milled PCBs have to be separated.

Up to 15 PCBs arranged next to one another can be separated simultaneously. 310 mm is the maximum passage width. The distances and the number of circular blades are adapted to the PCB. Solid and precisely manufactured blade shafts ensure smooth PCB separation. The hardened and ground and titanium-coated circular blades achieve a high running performance.

PCBs are inserted to the guide manually or are fed automatically by a loader resp. an external conveyor belt. When separated, the PCBs are deposited on the built-in conveyor belt.

A SMEMA interface provided, installation in an assembly line is possible (for information see the operator's manual). With the help of a base frame vertically adjustable, MAESTRO 5L can be adapted to any application. A possibility to connect an extraction and filter device is in preparation.

Outside dimensions increased after separation: typically 0.2 mm

The milled groove may be interrupted by cutouts.

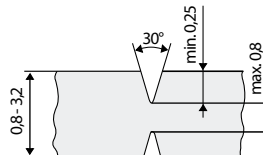

Technical data	
Separation method	Component side Circular blade Solder side Circular blade
Operation	motor-driven
Separation speed	100 - 220 mm/s to be set in ten steps
PCB length light barrier activated light barrier deactivated	100 - 570 mm up to 2,000 mm
PCB width	up to 310 mm
Residual off-cut width	at least 3 mm
Component height	Component side up to 30 mm Solder side up to 10 mm
Number of circular blades	up to 16 per blade shaft
Programming	
Display	- Separation speed - Separation length resp. number of PCBs
Control buttons	- Start, Stop, Reverse
Programming button	- Separation speed setting
Monitoring	- Detection of separation length - Accumulation before / behind the blades - Conveyor belt finally stopping
Interfaces	- external start / stop - SMEMA (round, 14 pins)
Power supply	230/115 VAC, 50/60 Hz
Temperature / humidity not condensing	Operation + 10 - 35°C / 10 - 85 % Stock 0 - 60°C / 20 - 80 % Transport - 25 - 60°C / 20 - 80 %
Width x Height x Depth	440 x 750 - 1,000 x 1,100 mm
Weight	63 kg
Approvals	CE, FCC Class A

Part no.	Product
8934520	PCB separator MAESTRO 5L neither circular blade or protective cover The blade shaft has to be ordered separately. It is assembled to the device and adjusted ex factory by the manufacturer.
893xxxx 893xxxx	Blade shaft assembled Device-specific parts
Scope of delivery	PCB separator, base frame Power cable Type E+F, length 1.8 m Service tool Warning light Auxiliary device for blade shaft Rest, entirely End piece for extraction Operator's manual DE/EN
Part no.	Wear parts
8934803.001	Circular blade, width 8 mm
893xxxx.001	Circular blade, customer-specific

PCB separator MAESTRO 6



Separation of milled PCBs up to a length of 1,500 mm with a minimum of stress on the components

The MAESTRO 6 is the consequent further development of the proven cab PCB separators. Even very lengthy PCBs can be separated fast, economical and without stress.

The carriage power unit is assembled behind the linear blade. This crucially simplifies the separation and removal of the PCBs.

Dial gauge

In order to separate without stress and to achieve a long service life, the circular and linear blades have to be guided along the entire separation. The dial gauge setting and regularly checking the parallelism is assembled to the carriage.



Overall technical data	
Separation method	Component side Circular blade Solder side Linear blade
Operation	path-optimized
Separation speed	up to 500 mm/s up to 250 mm/s with aluminum
Support table depth	160 mm
Operation panel	
Control buttons	- Home / Position - Carriage moving to and fro
Programming buttons	- Carriage start / stop position - Carriage moving to and fro with or without interruption - Separation speed - "Number of cuts" or "Separation length" selection - Deletion of selection - Conveyor belt activation - Belt speed
Power switcher	ON/OFF
Foot switch	START separation
Safety switch	E-stop
Power supply	100 - 240 VAC, 50/60 Hz
Emission sound pressure level	LpA < 70 dB (A)
Temperature / humidity	Operation + 10 - 35°C / 10 - 85 % Stock 0 - 60°C / 20 - 80 %
not condensing	Transport - 25 - 60°C / 20 - 80 %
Approvals	CE, FCC Class A

Outside dimensions increased after separation: typically 0.2 mm

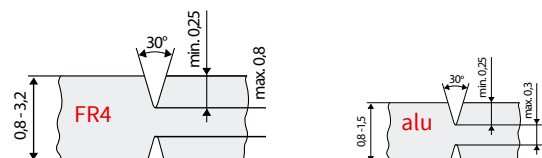

The milled groove may be interrupted by cutouts.

Protruding components need a recessed linear blade. Contact us, if required

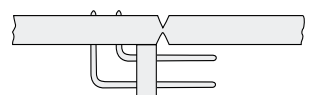

PCB separator MAESTRO 6

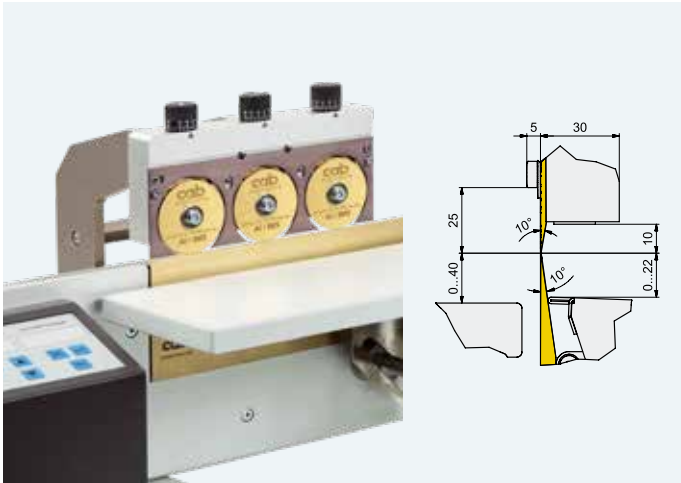

Part no.	Product	Sep. length
8936510	PCB separator MAESTRO 6/603	up to 600 mm
8936500	PCB separator MAESTRO 6/903	up to 900 mm
8936490	PCB separator MAESTRO 6/1203	up to 1.200 mm
8936570	PCB separator MAESTRO 6/1503	up to 1.500 mm
8936xxx.520	PCB separator MAESTRO 6/xx03 alu	
Scope of delivery	PCB separator Power cable Type E+F, length 1.8 m Foot switch Allen key 2 mm Dial gauge Operator's manual DE/EN	



MAESTRO 6/X03

Separation of FR4, CEM3 and aluminum PCBs
up to lengths of 1,500 mm

Simple and quick change of FR4/CEM3 blades to aluminum blades or the other way round

Height of circular blades to the linear blade to be set individually

Technical data	6/603	6/903	6/1203	6/1503
Circular blade	diameter 60 mm			
Separation speed	up to 500 mm/s up to 250 mm/s with aluminum			
Materials	FR4, CEM3, aluminum			
Component height	Component side up to 10 mm Solder side up to 22 mm			
Width	1,150 mm	1,450 mm	1,750 mm	2,050 mm
Height x Depth	350 x 450 mm			
Weight	50 kg	55 kg	60 kg	65 kg

Part no.	Wear parts	
8936446.001	Circular blade 60 FR4	
8936507.001	Circular blade 60 alu	
8936593.001	Linear blade 450	
8936592.001	Linear blade 600	
8936437.001	Blade protection X03	

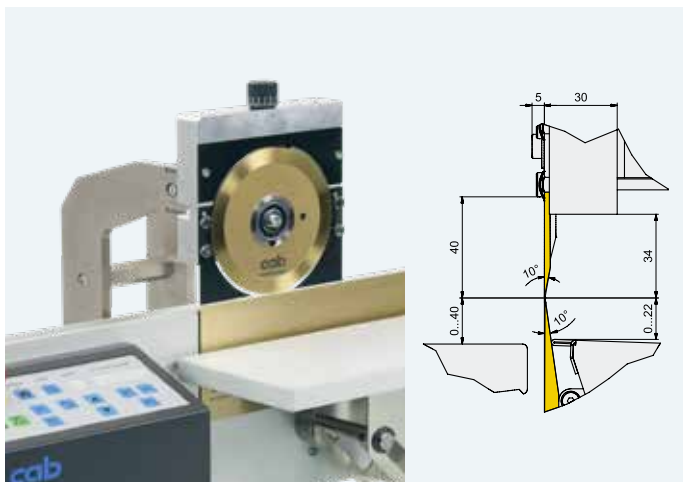



Part no.	Product	Sep. length
8936560	PCB separator MAESTRO 6/601	up to 600 mm
8936580	PCB separator MAESTRO 6/901	up to 900 mm
Scope of delivery	PCB separator Power cable Type E+F, length 1.8 m Foot switch Allen key 2 mm Dial gauge Operator's manual DE/EN	

MAESTRO 6/X01

Separation of FR4 and CEM3 PCBs up to lengths of 900 mm;
further lengths on request

Technical data	6/601	6/901
Circular blade	diameter 125 mm	
Separation speed	up to 500 mm/s	
Materials	FR4, CEM3	
Component height	Component side up to 34 mm Solder side up to 22 mm	
Width x Height x Depth	1,150 x 410 x 450 mm	1,450 x 410 x 450 mm
Weight	50 kg	55 kg

Part no.	Wear parts	
8930509.001	Circular blade 125 FR4	
8936593.001	Linear blade 450	
8936592.001	Linear blade 600	
8936614.001	Blade protection 1 X01	
8936615.001	Blade protection 2 X01	

PCB separator MAESTRO 6

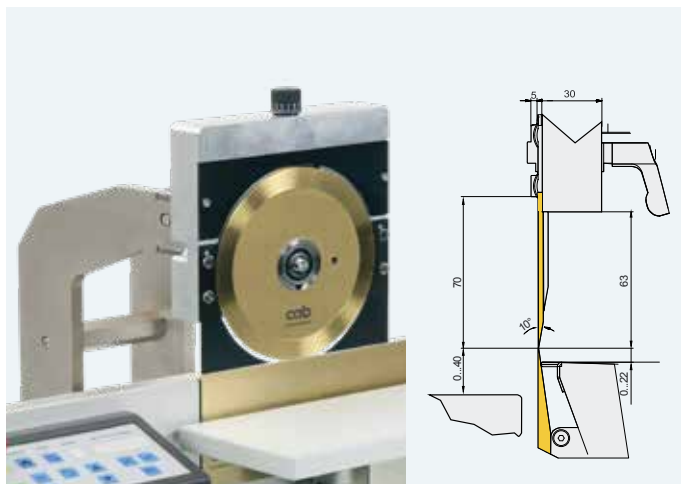

MAESTRO 6/601.70

Separation of FR4 and CEM3 PCBs up to lengths of 600 mm and component heights of 70 mm; further lengths on request

Technical data	6/601.70
Circular blade	diameter 185 mm
Separation speed	up to 500 mm/s
Materials	FR4, CEM3
Component height	Component side up to 63 mm Solder side up to 22 mm
Width x Height x Depth	1,150 x 410 x 450 mm
Weight	50 kg

Part no.	Product	Sep. length
8936590	PCB separator MAESTRO 6/601.70	up to 600 mm
Scope of delivery	PCB separator Power cable Type E+F, length 1.8 m Foot switch Allen key 2 mm Dial gauge Operator's manual DE/EN	

Part no.	Wear parts	
8933933.001	Circular blade 185	
8936593.001 8936592.001	Linear blade 450 Linear blade 600	
8936583.001 8936584.001	Blade protection 1 X01/70 Blade protection 2 X01/70	

PCB magazine series 100, 180, 300

providing 32 PCB slots



To be equipped both in vertical and horizontal orientation

The system's variable width enables individual assembly according to any PCB size.

Magazines 100, 180 and 300 mm in height are offered for the various PCBs.

32 slots in gaps of 10 mm offer maximum packing density.

Safe guidance

Funnel-shaped slot entries ensure safe PCB insertion. Yellow position stickers indicate the exact positions and prevent from falsely inserting PCBs diagonally by hand.

Consecutive numbers and markings

Carry handle to be retracted

Bracket for accompanying documents

Doubled side wall

Support rail to secure heavy PCBs

Profile rail

Free space to protect protruding components

17 mm

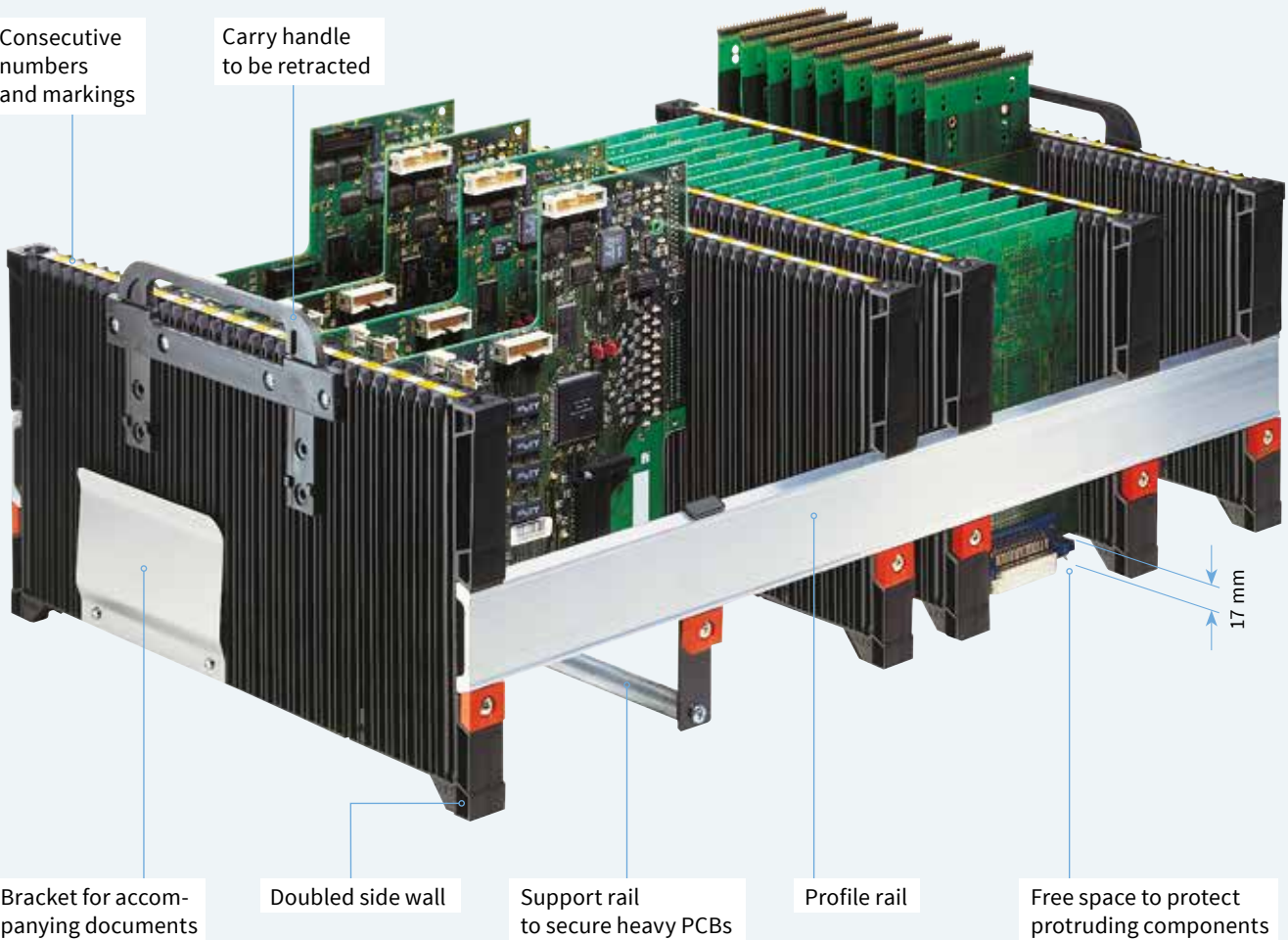

PCB magazine series 100, 180, 300



Quick and simple assembly

The side walls are adjustable with the help of the profile rails. Two PCBs are inserted in the outer adjusting grooves. The upper side wall has to be pressed against the PCBs and be fixed with screws.



Solid and resistant to torsion

The double-wall construction makes the side walls extremely solid. A metal tube is provided to further stiffen a side wall in the case of high mechanic and thermal forces.



Slot lock

To prevent from component damage when inserting PCBs in a magazine, slots that are not in use can be covered.



Stackable

Boreholes and pins on the outer margins allow the magazines to be stacked. On the bottom of the side walls, molded recesses simplify the lifting.



Upright position

Assembled PCBs need horizontal storage before soldering. For this purpose, the magazines are set upright.



Transport boxes

The magazines can be inserted into standard 600 x 400 resp. 400 x 300 mm boxes for transport. Retractable carry handles simplify the insertion and removal.

Technical data	100	180	300
Material	Polypropylene		
Color	black		
Surface resistance	accord. to DIN EN 61340-5-1 <10 ⁹		
Slot width	2.8 mm	4 mm	3.5 mm
Slot depth	2 mm	2.5 mm	2.5 mm
Number of slots	32		
Distance between the PCBs	10 mm		

Length of profile rails

D = PCB width x = profile rail width

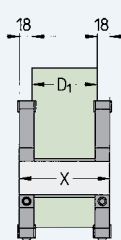

$$x = 36 + D1$$

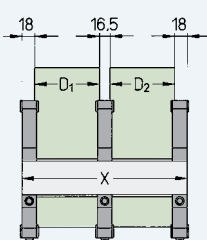

$$x = 52 + D1 + D2$$

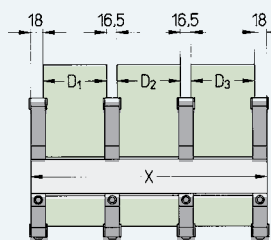

$$x = 69 + D1 + D2 + D3$$

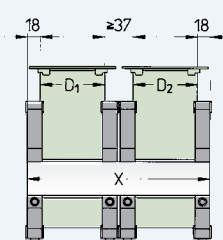



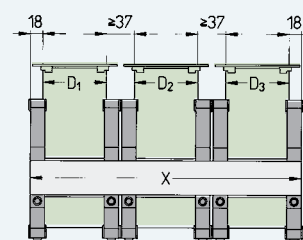

$$x \geq 73 + D1 + D2$$

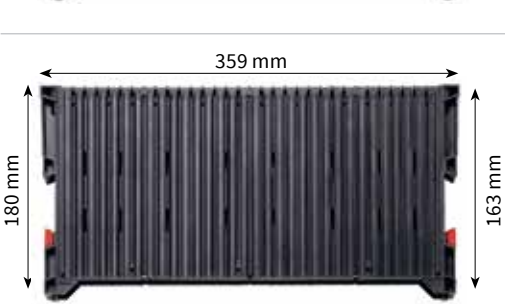
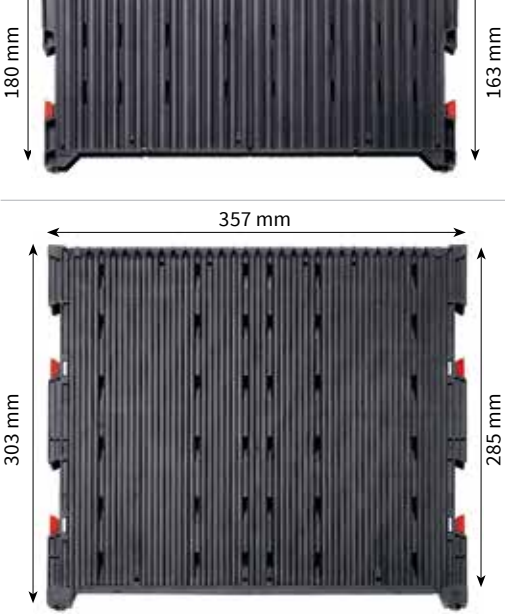

$$x \geq 110 + D1 + D2 + D3$$

PCB magazine series 100, 180, 300

Delivery program

	Part no.	Product	Weight
	8910050	Side wall 100	0.28 kg
	8910102	Side wall 100 reinforced	0.40 kg
	8913913	Side wall 100 with boreholes for slot locks	0.28 kg
	8910060	Side wall 180	0.53 kg
	8910104	Side wall 180 reinforced	0.65 kg
		with boreholes for slot locks	
	8912049	Side wall 300	0.7 kg
	8913914	Side wall 300 with boreholes for slot locks	0.7 kg
			
		Length in mm	
	8910136	Profile rail 0136	0.06 kg
	8910252	Profile rail 0252	0.11 kg
	8910547	Profile rail 0547	0.24 kg
	8911000	Profile rail 1000	0.45 kg
	8912000	Profile rail 2000	0.90 kg
	8913000	Profile rail 3000	1.35 kg
	891xxxx	Profile rail xxxx	
<p>The profile rails are cut according to your instructions. xxxx is the desired length in mm.</p>			
	8910009	Bracket for accompanying documents	
	8912004	Support rail 100	
	8912005	Support rail 180	
	8912006	Support rail 300	
	8912007	Carry handle 100	
	8910097	Carry handle 180/300	Pack unit: 1 set
	8913916	Slot lock 1	
	8913917	Slot lock 2	
<p>Slot lock 1 Slot lock 2 enlarged display</p>		Pack unit: 100 sets each	

PCB magazine series 600, 700, 800

Automation requires precision when magazines are in use in assembly lines.



- 1 **Knobs**
for magazine stacking
- 2 **Base and cover plates**
made of cast aluminum or sheet steel
- 3 **Numbering**
along the PCB slots simplifies manual insertion.
- 4 **Side walls**
made of conductive plastic or metal to be operated in ambient temperatures of 50 to 200°C
- 5 **Transport lock**
A bar is mounted as a standard on the front and back sides.



Slots locked



Slots unlocked



Metal magazine

In the case of high mechanic force and high thermal force up to 200°C, metal side walls are provided.

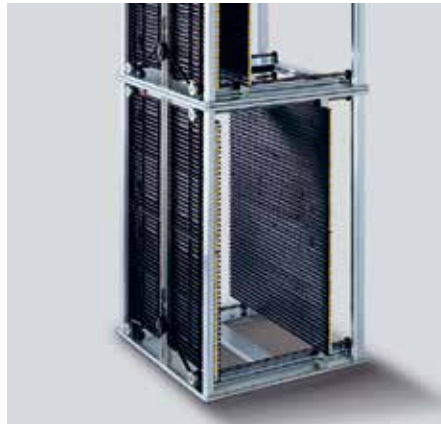

Safe stacking

All the magazines can be stacked safely and in a space-saving manner with the help of our knobs provided on the upper plate.



Perfecting operation

Its vertical symmetry allows the magazines to be turned upside down if use is in perfecting mode. To be operated only without stacking knobs

PCB magazine series 600, 700, 800

Dimensional drawing

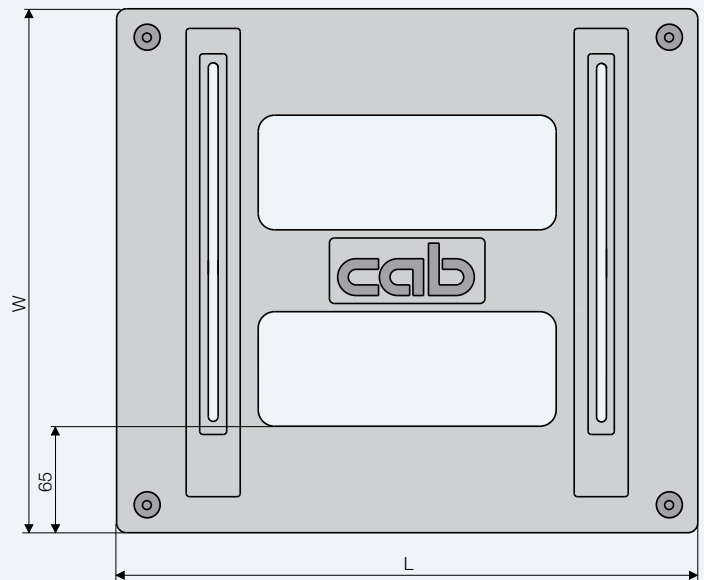
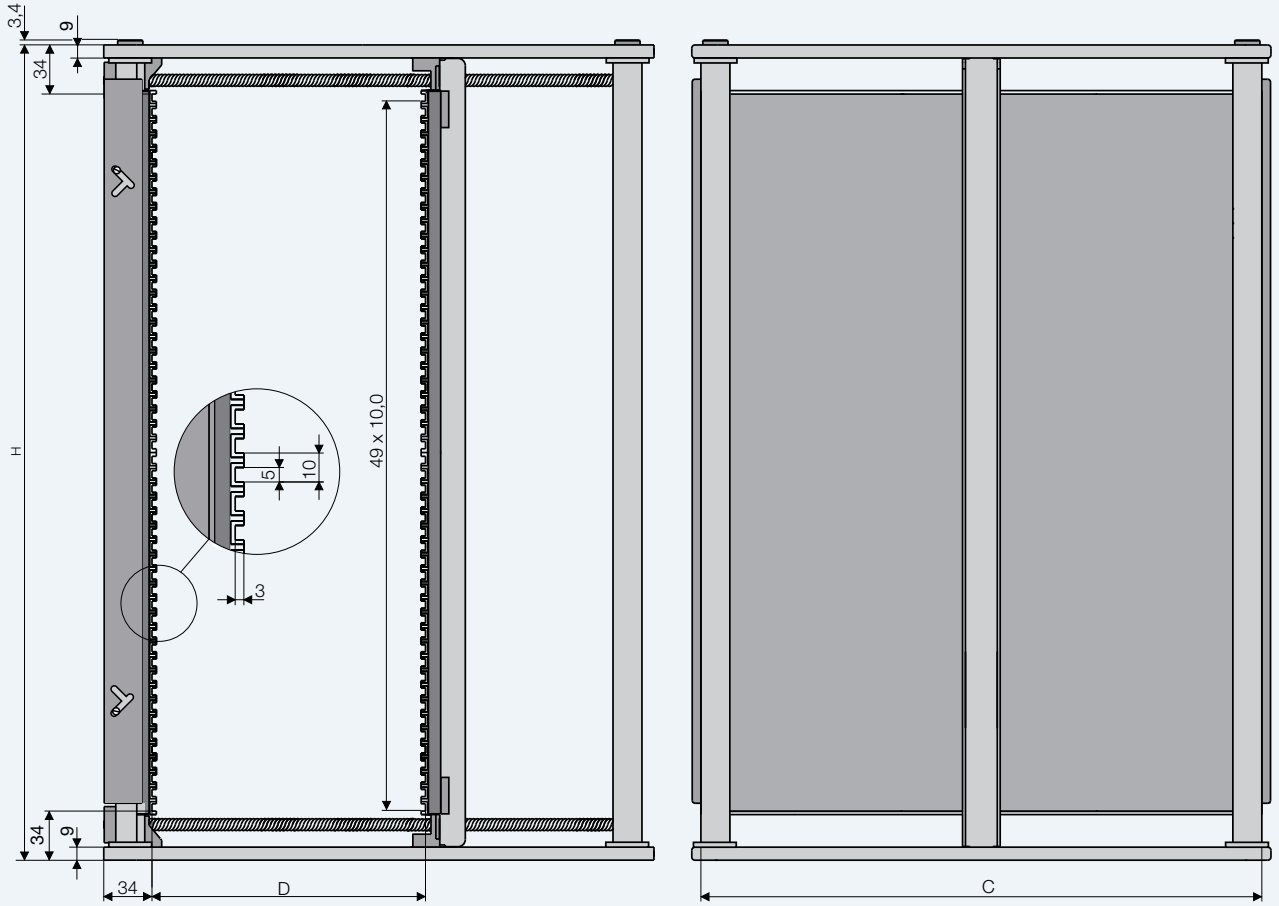

Type			Side wall material	Surface resistance
60X.1	70X.1	80X.1	Polystyrene	according to DIN EN 61340-5-1 10^9
60X.2	70X.2	80X.2	Polycarbonate	
60X.3	70X.3	80X.3	Metal*	

*as measured on the side wall to frame

PCB magazine series 600

Screw-clamped width setting



1 Transport lock

A bar is mounted as a standard on the front and back sides. At lifting, the bar is moved to the outside and locks in upper position. The PCBs can be inserted or removed. When lifting again, the slots are locked.

2 Screw clamps

Series 600 magazines are cost-effective. With the help of four screw clamps, the side wall can be set to the PCB width.

Type	Part no.	Side wall material	Temperature °C		Weight kg	Outside dimensions			PCB	
			Insertions	Surrounding		Width W mm	Length L mm	Height H mm	Width D mm	Length C up to mm
601.1	8917601	Polystyrene	60	50	5.6	320	355	563	40 - 250	342
601.2	8916601	Polycarbonate	130	80	5.9					
601.3	8915601	Metal	200	200	6.9					
602.1	8917602	Polystyrene	60	50	5.8	320	400	563	40 - 250	387
602.2	8916602	Polycarbonate	130	80	6.1					
602.3	8915602	Metal	200	200	7.2					
603.1	8917603	Polystyrene	60	50	6.2	380	400	563	40 - 310	387
603.2	8916603	Polycarbonate	130	80	6.5					
603.3	8915603	Metal	200	200	7.6					

The **PCB magazines 60X.1** and **60X.2** are delivered partially assembled.

Assembled magazines to be ordered with an additional part no.:

DL31001		assembled with stacking knobs
DL 31002		assembled for perfecting operation

The **PCB magazines 60X.3** are delivered assembled with stacking knobs.

further sizes on request

PCB magazine series 700

Variable width setting by pulling the gear belt by hand

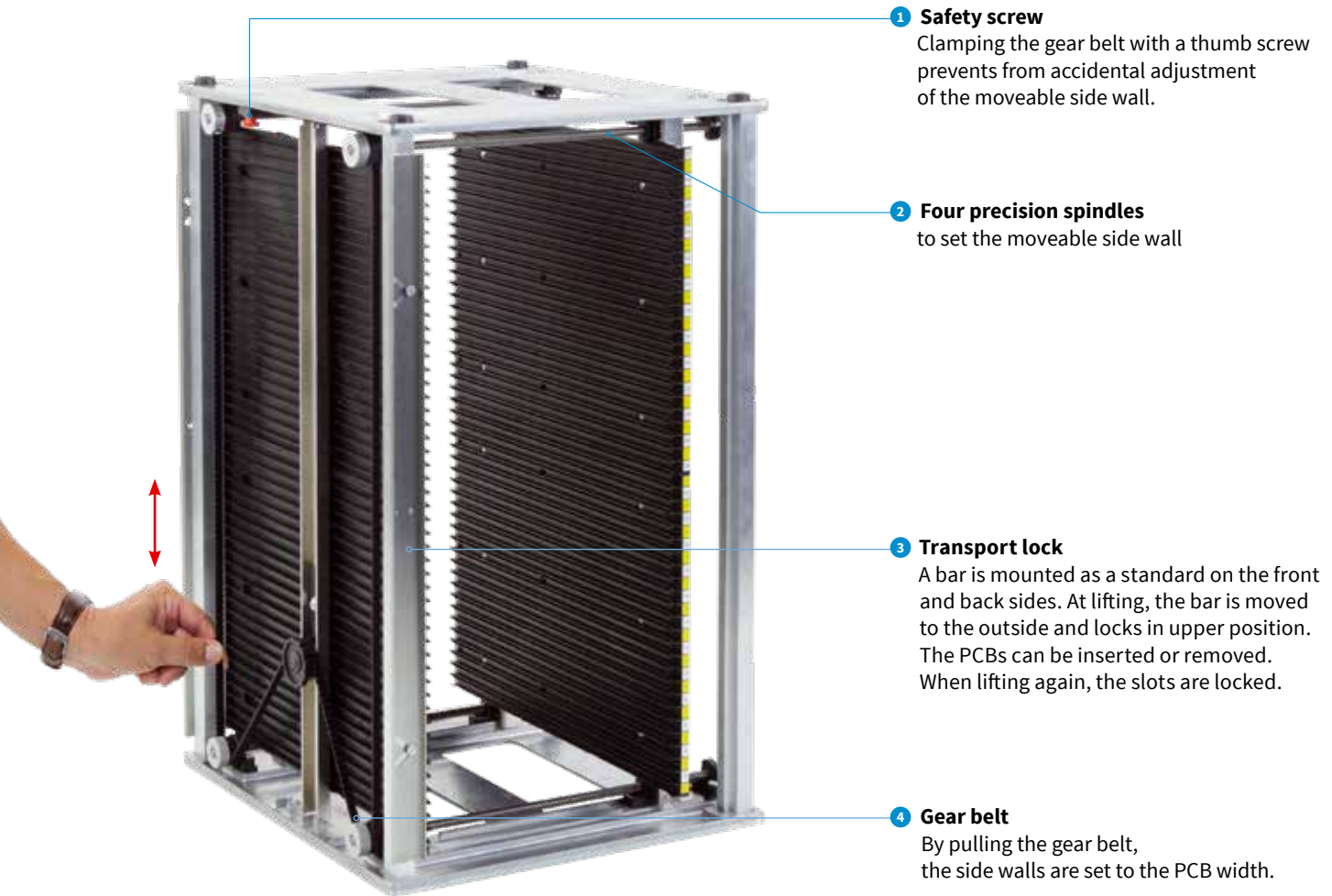

1 Safety screw

Clamping the gear belt with a thumb screw prevents from accidental adjustment of the moveable side wall.

2 Four precision spindles

to set the moveable side wall

3 Transport lock

A bar is mounted as a standard on the front and back sides. At lifting, the bar is moved to the outside and locks in upper position. The PCBs can be inserted or removed. When lifting again, the slots are locked.

4 Gear belt

By pulling the gear belt, the side walls are set to the PCB width.

Type	Part no.	Side wall material	Temperature °C		Weight kg	Outside dimensions			PCB	
			Insertions	Surrounding		Width W	Length L	Height H	Width D	Length C
701.1	8917701	Polystyrene	60	50	5.6	320	355	563	40 - 250	342
701.2	8916701	Polycarbonate	130	80	5.9					
701.3	8915701	Metal	200	100	6.9					
702.1	8917702	Polystyrene	60	50	5.8	320	400	563	40 - 250	387
702.2	8916702	Polycarbonate	130	80	6.1					
702.3	8915702	Metal	200	100	7.2					
703.1	8917703	Polystyrene	60	50	6.2	380	400	563	40 - 310	387
703.2	8916703	Polycarbonate	130	80	6.5					
703.3	8915703	Metal	200	100	7.6					
704.1	8917704	Polystyrene	60	50	7.8	400	460	563	10 - 330	447
704.2	8916704	Polycarbonate	130	80	8.0					
704.3	8915704	Metal	200	100	9.5					
716.2	8916716	Polycarbonate	130	80	9.5	460	535	563	10 - 390	522
716.3	8915716	Metal	200	100	10.9					
717.2	8916717	Polycarbonate	130	80	9.7	530	535	563	10 - 460	522
717.3	8915717	Metal	200	100	11.1					

The **PCB magazines 70X.1** and **70X.2** are delivered partially assembled.

Assembled magazines to be ordered with an additional part no.:

DL31001		assembled with stacking knobs
DL 31002		assembled for perfecting operation

The **PCB magazines 70X.3** are delivered assembled with stacking knobs.

further sizes on request

PCB magazine series 800

Variable width setting by pulling the gear belt motor-driven or by hand

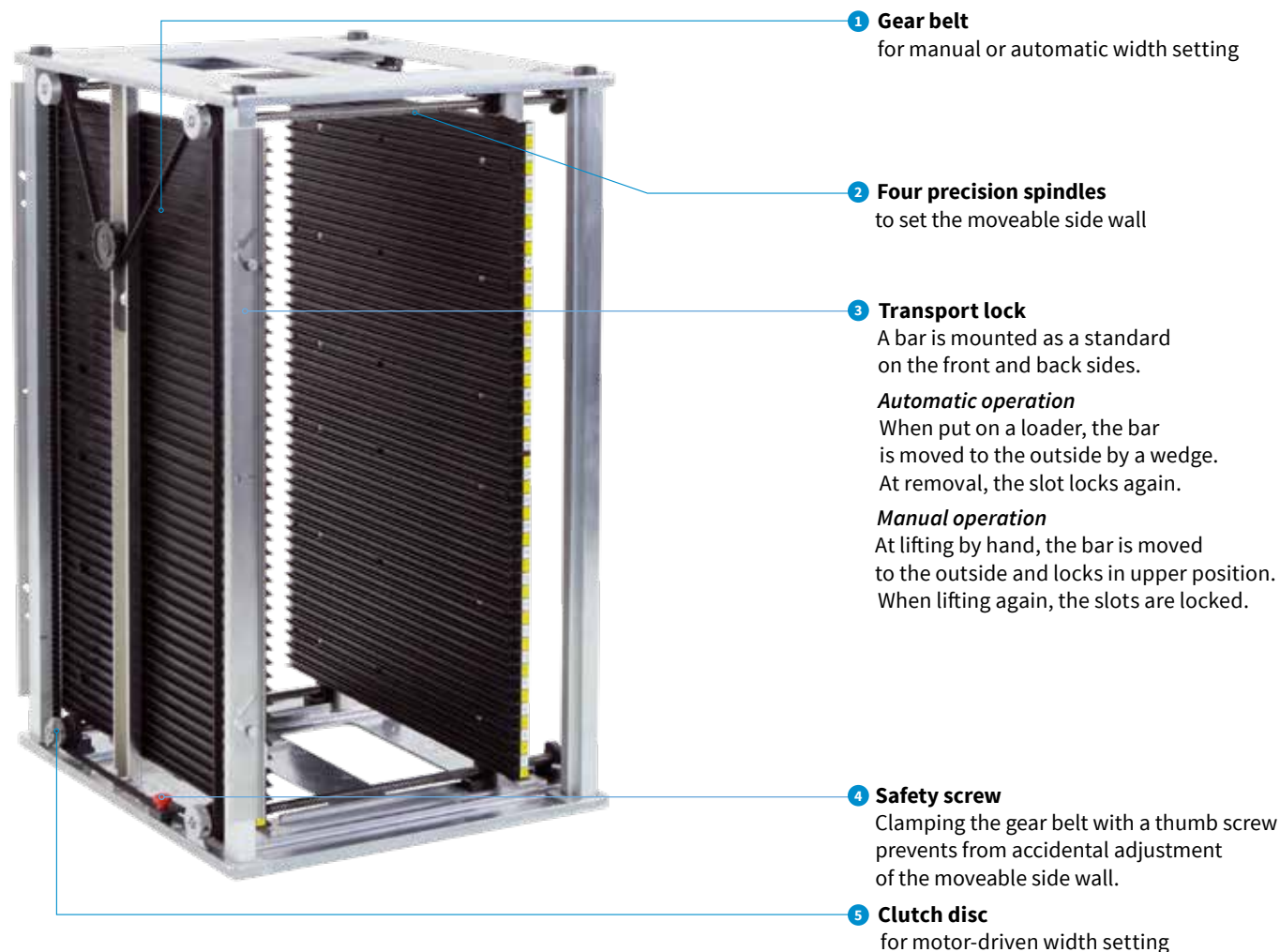

Type	Part no.	Side wall material	Temperature °C		Weight kg	Outside dimensions			PCB	
			Insertions	Surrounding		Width W	Length L	Height H	Width D	Length C
801.1	8919801	Polystyrene	60	50	5.6	320	355	563	40 - 250	342
801.2	8918801	Polycarbonate	130	80	5.9					
801.3	8915801	Metal	200	100	6.9					
802.1	8919802	Polystyrene	60	50	5.8	320	400	563	40 - 250	387
802.2	8918802	Polycarbonate	130	80	6.1					
802.3	8916740	Metal	200	100	7.2					
803.1	8919803	Polystyrene	60	50	6.2	380	400	563	40 - 310	387
803.2	8916745	Polycarbonate	130	80	6.5					
803.3	8915803	Metal	200	100	7.6					
804.1	8919804	Polystyrene	60	50	7.8	400	460	563	10 - 330	447
804.2	8918804	Polycarbonate	130	80	8.0					
804.3	8915804	Metal	200	100	9.5					
816.2	8916816	Polycarbonate	130	80	9.5	460	535	563	10 - 390	522
816.3	8915816	Metal	200	100	10.9					
817.2	8916817	Polycarbonate	130	80	9.7	530	535	563	10 - 460	522
817.3	8915817	Metal	200	100	11.1					

The **PCB magazines 80X.1** and **80X.2** are delivered partially assembled.

Assembled magazines to be ordered with an additional part no.:

DL31001		assembled with stacking knobs
---------	---	-------------------------------

The **PCB magazines 80X.3** are delivered assembled with stacking knobs.

further sizes on request

PCB magazine series 600, 700, 800

Accessories



Slot lock

to lock the slots on magazines with plastic side walls.
The clipping on and removal need no additional tools.

A slot lock in use reduces the maximum PCB width setting by 3 mm.

Pos.	Part no.	Product	Pack unit
1.1	8916571	Slot lock 1 (onefold)	100
1.2	8916575	Slot lock 5 (fivefold)	20



Bracket

to attach accompanying documents
on magazines with plastic side walls.

Part no.	Product	Pack unit
8913416	Bracket	1



Protective cover

It prevents PCBs inserted in a magazine from pollution.
conductive, solid, tear-proof
Material: Permastat ESD
Color: pink / thickness: 150 µm

Magazine type	Part no.	Pack unit
601, 701, 801	8916411	10
602, 702, 802	8916412	10
603, 703, 803	8916413	10
704, 804	8916414	10
716, 816	8916416	10
717, 817	8916417	10

Special magazines



Low structural height for series 600, 700, 800 magazines

Low height PCB magazines, e.g. in use in annealing furnaces;
Reducing the height also prevents from overload in the case of heavy PCBs or product carriers in use.

Side wall material: metal; plastic on request

Type	Part no.	Temperature °C		Weight kg	Outside dimensions			Insertions	Screw clamping	Gear belt
		Insertions	Surrounding		L mm	W mm	H mm			
601.3	8916130	200	200	5.5	355	320	343	28	■	-
701.3	8916410	200	100	5.9	355	320	263	20	-	■
701.3	8916175	200	100	6.1	355	320	343	28	-	■



Twin and triple magazines of the 700 series to process long PCBs

The magazines are assembled torsion resistant.

PCBs up to 1,187 mm in width can be stored safely and transported.

Side wall material: polycarbonate

Twin magazines are delivered fully assembled.

Triple magazines are delivered partially assembled.

Type	Part no.	Temperature °C		Weight kg	Outside dimensions			PCB		
		Insertions	Surrounding		L mm	W mm	H mm	Width D		Length C
							min. mm	up to mm	up to mm	
701.2-2	8916712	130	80	12.3	710	320	563	40	250	697
702.2-2	8916722	130	80	12.7	800	320	563	40	250	787
703.2-2	8916732	130	80	13.5	800	380	563	40	310	787
701.2-3	8916713	130	80	18.7	1,065	320	563	40	250	1,052
702.2-3	8916723	130	80	19.3	1,200	320	563	40	250	1,187
703.2-3	8916733	130	80	20.5	1,200	380	563	40	310	1,187

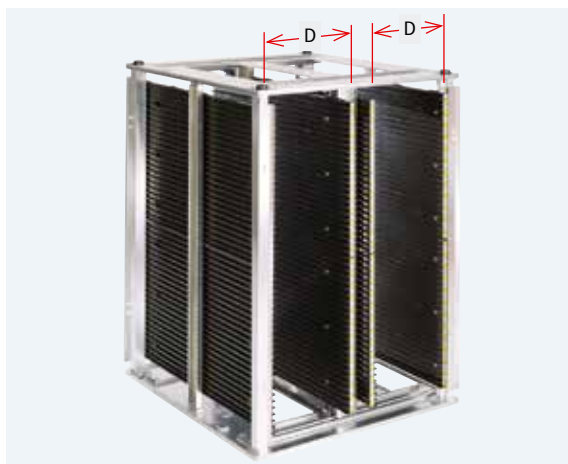

Doubled capacity by parallel insertion in series 600 magazines

Up to 100 PCBs put in one magazine; In the case of narrow PCBs, magazines with two insertion units can be used side by side.

Side wall materials: polystyrene, polycarbonate, metal

Type	Part no.	Temperature °C		Outside dimensions			PCB		
		Insertions	Surrounding	L mm	W mm	H mm	Width D		Length C
							min. mm	up to mm	up to mm
601.1-P	8916435	60	50	355	320	563	40	100	342
601.2-P	8915485	130	100	355	320	563	40	100	342
603.2-P	8916425	130	100	400	380	563	40	100	387
603.3-P	8916395	200	200	400	380	563	40	100	387

cab product overview

Label printers
MACH1, MACH2



Label printers
EOS 2



Label printers
EOS 5



Label printers
MACH 4S



Label printers
SQUIX 2



Label printers
SQUIX 4



Label printers
SQUIX 6.3



Label printer
A8+



Label printer
XD4T



Label printers
XC



Print and apply systems
HERMES Q



Print and apply systems
Hermes C

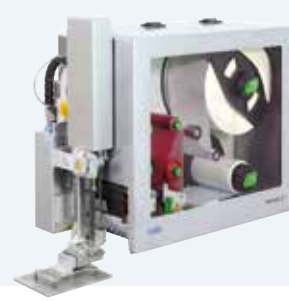

Tube labeling systems
AXON



Print modules
PX Q



Labels and ribbons



Label software
cablabel S3



Label dispensers
HS, VS



Labeling heads
IXOR



Marking lasers
XENO 4



Laser marking systems



Germany

cab Produkttechnik GmbH & Co KG

Karlsruhe

Phone +49 721 6626 0

www.cab.de

France

cab Technologies S.à.r.l.

Niedermodern

Phone +33 388 722501

www.cab.de/fr

USA

cab Technology, Inc.

Chelmsford, MA

Phone +1 978 250 8321

www.cab.de/us

Mexico

cab Technology, Inc.

Juárez

Phone +52 656 682 4301

www.cab.de/es

Taiwan

cab Technology Co., Ltd.

Taipei

Phone +886 (02) 8227 3966

www.cab.de/tw

China

cab (Shanghai) Trading Co., Ltd.

Shanghai

Phone +86 (021) 6236 3161

www.cab.de/cn

China

cab (Shanghai) Trading Co., Ltd.

Guangzhou

Phone +86 (020) 2831 7358

www.cab.de/cn

South Africa

cab Technology (Pty) Ltd.

Randburg

Phone +27 11 886 3580

www.cab.de/za

cab // 820 distribution partners in more than 80 countries

cab
we identify more