



Dispensing **Solutions**



The core of our Ultra System

Which components would you rather use?



It's the unique design and production of EFD syringe barrels, pistons and dispense tips that significantly improve assembly fluid applications. The Ultra system makes dispensing easier, more controlled and safer, and these features translate directly into reduced costs.

If your dispense tip is blocked by metal burrs or "flash" from the molding process, if the syringe barrel is contaminated with dust or silicone, or if the piston isn't a precise fit, the amount of fluid you apply is going to vary.

Unfortunately, most disposable components look pretty similar from the outside. Companies that think they're saving money with "budget" tips and barrels often don't realize there is a difference — until reject rates start to climb, or even worse, their products fail in the field.

Consistent Components = Consistent Fluid Deposits

With an EFD dispense system, you never worry about these problems. All EFD dispense tips, syringe barrels and pistons are precision molded in our own silicone-free US facilities, rigorously inspected and carefully packaged in clean, contaminant-free containers. Consistent product performance is guaranteed.

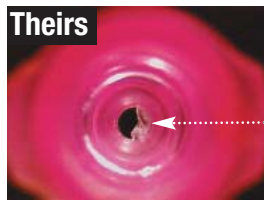

"Flash" inside hub restricts flow and reduces accuracy.

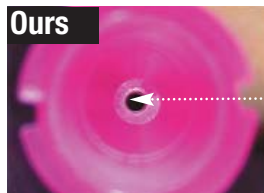

EFD hubs provide unrestricted flow and produce accurate consistent deposits.

EFD tubing is carefully polished and burr-free.

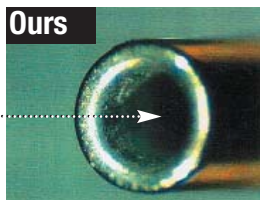

Burrs and flaws inside reduce accuracy.

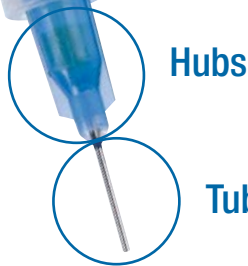
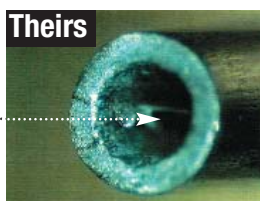

EFD[®]
A NORDSON COMPANY

QUALITY COSTS LESS.

Introduction

Whether you apply watery thin fluids or thick pastes, we can show you how to [significantly cut costs](#), get better products and reduce fluid usage up to 75%.

This is what we do. And, we guarantee the results.

While you can sort through all the features and options of our dispenser/component products, we recommend you [call one of our experienced Fluid Application Specialists](#). Our business is to match your very specific application needs with our wide range of dispensing tools to maximize your total cost savings.

We are an unusual company. Our no-compromise quality and service are unequalled. Our [no-hassle guarantee](#), like our company, is rock solid and unequivocal.

We look forward to being of service.

Contents

Dispensing systems

Air-powered 4-6

Mechanical 7

Hand-lever valves 8-9

Portable 10

Components 11-15

Cartridge systems 16

Syringe barrel loaders 17

Accessories 18-19

Dispense any assembly fluid accurately and consistently

epoxies
cyanoacrylates
solvents
sealants
grease
anaerobics
lubricants
coatings
flux
silicones
pastes
gels
electrolytes
oils
activators
marking inks
uv-cure
... and more!

“For 12 years, I have purchased your equipment. What can I say? **It works and works and works...** Keep up the great job!”

Charles Bissot, AMP Inc.

Ultra 2400 Series



Key Features

- ◆ All-digital, multi-function display with simultaneous readouts of air pressure, time and vacuum
- ◆ Password to lock out operator changes
- ◆ High speed solenoid for highly accurate deposits
- ◆ Universal power supply includes plug adapters for immediate use in any country
- ◆ Multilingual display, selectable on-site for English, French, German, Spanish, Italian, Japanese, Chinese or Korean
- ◆ Unique air management system provides rapid response and stabilizes cycle-to-cycle control
- ◆ Time increment adjustments as small as .0001 seconds for precise deposit control
- ◆ Selectable unit display — psi, bar or kPa for pressure; inH₂O, inHg, kPa, mmHg or Torr for vacuum
- ◆ Easy to use “Teach” function for initial setup



Dispensing kit includes components customized to your application.

Dispensing Workstation

When it comes to applying assembly fluids — from watery thin solvents to thick silicones and paste-like epoxies — the innovative Ultra 2400 Series provide the most complete control available today.

The compact cabinet requires minimal work space, yet packs a powerful punch both inside and outside the box. A unique air management and high-speed solenoid work together for consistent deposit control. Work panels allow attachment of workstation lighting, ergonomic hand pieces, flexible syringe barrel mounting options or other beneficial tools for your specific application.

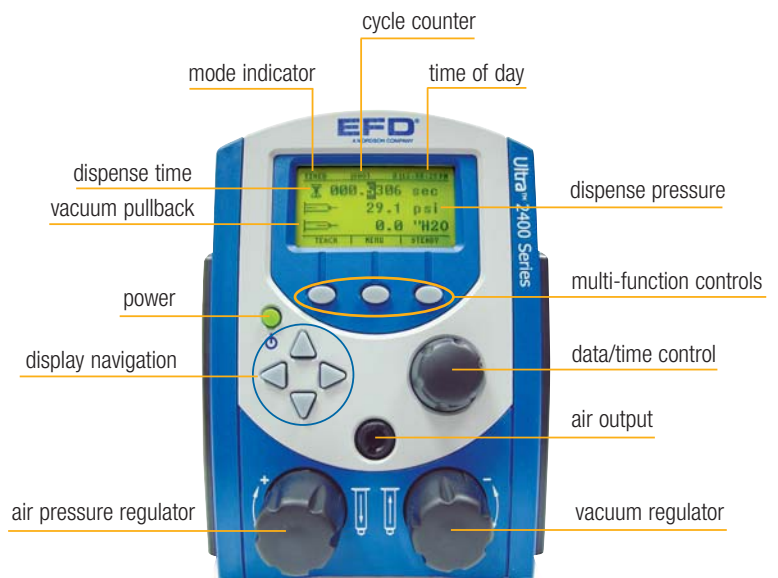

Models

- 2400:** 0 to 100 psi (0 to 6.9 bar); all fluids
- 2415:** 0 to 15 psi (0 to 1.0 bar); watery fluids
- 2405:** 0 to 5 psi (0 to 0.34 bar); micro deposits of very thin fluids

Specifications

- Cabinet size:** 5.63w x 7.12h x 6.82d" (14.3 x 18.1 x 17.3 cm)
- Weight:** 5.0 lb (2.3 kg)
- Cycle rate:** Exceeds 600 cycles per minute
- Time range:** 0.0001 to 999.9999 seconds
- Input voltage:** 100 to 240 VAC
- AC input frequency:** 47 to 63 Hz
- End-of-cycle feedback circuits:** 5 to 24 VDC 100 mA maximum
- Initiate circuits:** Foot pedal, finger switch or 5 to 24 VDC signal
- Meets or exceeds CE and CSA requirements**
- Warranty:** 10 years

“We save **41% in man-hours** equal to \$53/hour.” C.N.C.

Ultra 1400 Series

Fluid Dispensing Kit

Whether you apply cyanoacrylates or thick sealants, the versatile, easy-to-use Ultra 1400 dispenses accurate, consistent deposits. Helpful Teach function lets the operator establish deposit size, then stores time required for automatic, repeatable results.

The Ultra 1400 kit arrives ready for use. EFD quality dispensing components are matched to your specific application for optimum results.



Key Features

- ◆ Dispenses all assembly fluids
- ◆ Vacuum control for watery thin fluids
- ◆ Precise, digital display of dispense time, with microprocessor control
- ◆ Choose from three modes of operation: Timed, Steady or helpful Teach for initial deposit setup
- ◆ Compatible with all EFD Ultra components
- ◆ Compact, stackable design takes less space on the benchtop
- ◆ Versatile barrel holder mounts left or right based on operator preference

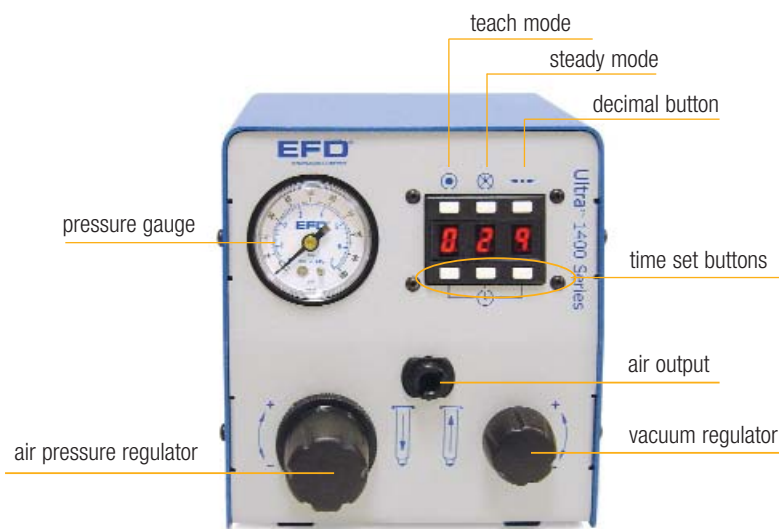

Specifications

Cabinet size: 5.25w x 5.94h x 6.00d"
(13.3 x 15.1 x 15.2 cm)

Weight: 3.0 lb (1.4 kg)

Time range: .001 to 99.9 seconds

Input voltage: Selectable 100/120/220 VAC

Initiate circuits: Foot pedal, finger switch
or 5 to 24 VDC signal

Time range: .001 to 99.9 seconds

Meets or exceeds CE and CSA requirements

Warranty: 2 years

Models

1400: 0 to 100 psi (0 to 6.9 bar);
all fluids

1415: 0 to 15 psi (0 to 1.0 bar);
watery fluids



Dispensing kit includes components customized to your application.

“Dispenser **paid for itself** in 3 weeks.” B.I.A.

Ultra 870 Series



Key Features

- ◆ All-pneumatic application of most assembly fluids
- ◆ Vacuum control for watery thin fluids
- ◆ Instant on/off controlled by pneumatic foot pedal
- ◆ Ideal for beading and potting



Dispensing kit includes components customized to your application.

Ultra 850D



Fluid Dispensing Kit

The economical Ultra 870 starter kit makes clean, fast work of applying beads, potting and other “by-eye” deposits. Instead of struggling with costly manual applicators like messy squeeze bottles, the adjustable air power lets users concentrate on getting the fluid exactly where it’s needed.

The Ultra 870 kit arrives ready for use. EFD quality dispensing components are matched to your specific application for optimum results.



Model

870: 0 to 100 psi (0 to 6.9 bar); all fluids

Specifications

Cabinet size: 5.25w x 5.94h x 6.00d"
(13.3 x 15.1 x 15.2 cm)

Weight: 2.1 lb (1.0 kg)

Warranty: 2 years

Pneumatic Dispenser

Fluid dispenser with analog air and vacuum control. 0-100 psi output. All pneumatic, wall-mounted. Complete with an introductory supply of dispensing components.

Model

850D: 0 to 100 psi (0 to 6.9 bar); all fluids

Specifications

Wall mounted

Ultra 2800 Series

Positive Displacement System

The Ultra 2800 Dispensing System brings positive displacement technology to applications that require precise metering of assembly fluids that change viscosity or where a specific flow rate is necessary.

Unique patented technology within the system uses a flexible drive cable driven by a powerful stepper motor, to apply consistent dots or beads of virtually any assembly fluid. The heavy-duty motor is contained within the benchtop controller, keeping the handheld reservoir system lightweight and easy to use.

For setup, the operator can use a menu-driven touch pad to set deposit volume (as small as 0.1 microliter), flow rate and other specific criteria. After initial setup, there is no need to recalibrate or reset the system due to changes in fluid viscosity or reservoir volume.

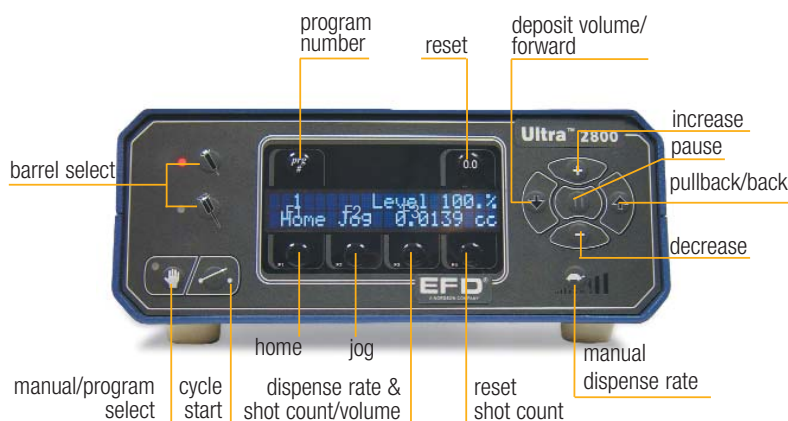

Specifications

- Size:** 7.25w x 3.18h x 12.73d" (18.4 x 8.1 x 32.3 cm)
- Weight:** 8.2 lb (3.7 kg)
- Cable assembly:** 6 ft length to end of handset (1.8 meters)
- Input voltage:** 100 to 240 VAC
- Meets or exceeds CE requirements**
- Warranty:** 2 years

Models

- 2800-3:** For 3cc syringe barrels
- 2800-5:** For 5cc syringe barrels
- 2800-10:** For 10cc syringe barrels
- 2800-30:** For 30cc syringe barrels



Key Features

- ◆ Highly repeatable, precise fluid control
- ◆ No need to recalibrate during operation
- ◆ All electric; does not require shop air
- ◆ Programmable pullback eliminates drooling
- ◆ Compatible with all EFD Ultra components
- ◆ All digital, multi-function display with readouts of deposit volume, rate, shot count, and more
- ◆ 100 user-defined memory cells that store shot volume, syringe barrel size, pullback, dispense rate, and pause



Dispensing kit includes components customized to your application.

Hand-Lever Dispense Valves



Key Features

- ◆ Ergonomic design
- ◆ Positive shutoff, no seals
- ◆ Very fine flow control

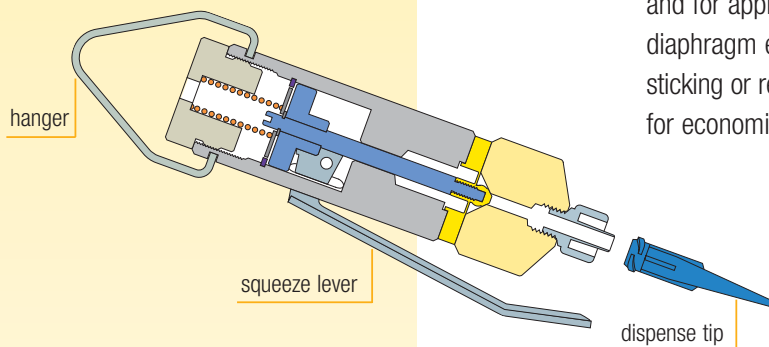

Key Features

- ◆ Ergonomic design
- ◆ Positive shutoff, no dripping
- ◆ Very fine fluid dead volume

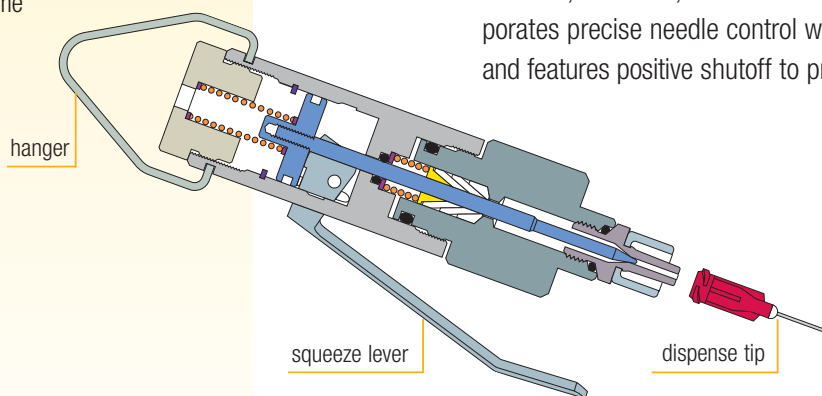

Hand Dispense Valves

Ergonomic, manually operated dispense valves solve many assembly applications where beads of sealants, lubricants or cyanoacrylates are required, and when flexibility, reach and large fluid reservoirs are needed. EFD hand lever valves allow a controllable flow rate and clean fluid cutoff from a (1) or (5) liter pressurized tank.

752V-HL

Designed specifically for precise dispensing of cyanoacrylates and anaerobics. The 752V-HL is ideal for making beads for gasket and grommet bonding, for MEK bonding of plastics, and for applying anaerobics to automotive parts. The flexible diaphragm ensures millions of trouble-free deposits without sticking or repairs. One liter tank accepts one-pound bottles for economical application.

740V-HL

Designed for dispensing precise beads and dots of low to medium viscosity fluids such as UV-cure adhesives, paints and inks, activators, and lubricants. The 740V-HL incorporates precise needle control with zero fluid dead volume and features positive shutoff to prevent dripping.

“Feeding directly from the adhesive bottle eliminates mess and refilling. We’re producing better-looking parts in **half the time**.” ECM Motor Co.

725-HL

Designed for dispensing thicker fluids such as epoxies, fluxes, sealants and wood glues. The 725-HL provides relatively high flow for heavy-duty operation, without maintenance or downtime. It features a piston design for clean, positive shutoff and end-of-cycle snuff-back.

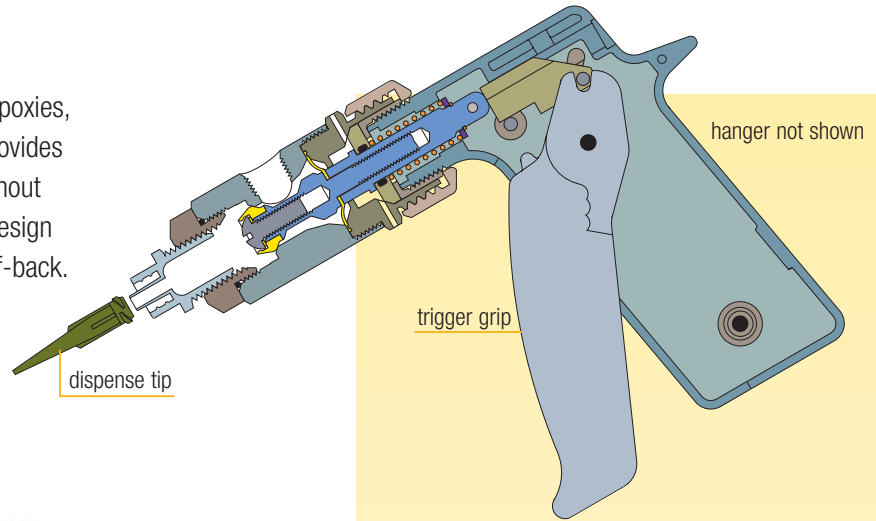

Key Features

- ◆ End-of-cycle snuff-back
- ◆ Ergonomic design
- ◆ Positive shutoff
- ◆ Simplified maintenance

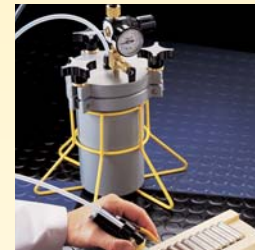

The System

Choosing the right tank is primarily based on two factors: how much fluid you are dispensing and whether the fluid is supplied in (1) pound or (1) liter bottles.

The air regulator is selected based on fluid viscosity. Watery fluids require the 0-15 psi regulator, while thicker fluids need the 0-100 psi regulator. Since tanks are charged by plant air, we recommend the five-micron filter regulator to filter contaminants. See accessories, page 19, for details.

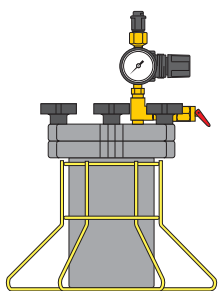

Model 615DTH:
1.0 liter tank

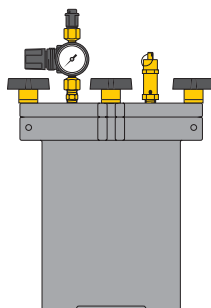

Model 626DTH:
5.0 liter tank

Tank reservoirs

Each tank is shipped complete with constant bleed precision air regulator and gauge, air hose, liner and fluid feed tubing.

Model	#615DTH	#626DTH
Tank body	cast aluminum	cast aluminum
Inside diameter	3.82 in.	6.81 in.
Inside depth	6.87 in.	9.75 in.
Replaceable liner	polyethylene	polyethylene
Liner capacity	0.95 liter	3.8 liters
Overall width	6.81 in.	11.14 in.
Overall height	14.01 in.	15.98 in.
Regulator & gauge	100 psi	100 psi
Max. operating pressure	100 psi	100 psi
Bottle size accepted	1 pound	1 liter
	#615DTL	#626DTL
Regulator & gauge	15 psi	15 psi

Portable Hand Dispensers



Unlike squeeze bottles or hypodermic-type syringes, EFD portable tools apply fluids without drip or ooze. They simplify fluid application in assembly, maintenance and field repair.

DispensGun®

To apply solder paste, sealants and grease, the DG DispensGun combines easy application with instant cutoff to prevent oozing. The DispensGun's 10:1 leverage makes it perfect for dispensing a range of medium to thick fluids.

Rugged, all-metal design comes in (5) sizes and accepts 3cc, 5cc, 10cc, 30cc and 55cc Ultra syringe barrels. Best for light assembly, field dispensing, touch-up and rework, each DispensGun features an adjustable hand trigger.

Accessories

- ◆ DG stand is made of heavy gauge wire and offers a convenient place to hold or store the DispensGun.
- ◆ Illuminator™ flashlight attaches to the DispensGun and provides targeted lighting.
- ◆ Field case provides durable, molded carrying case and includes space for dispense barrels and tips.

HPD™ HandPlunger

The unique reusable HPD is perfect for occasional assembly applications or for field repair kits. It features a low friction Ultra piston, so dispensing thick fluids like sealants, grease and pastes is easy and fatigue-free.

Available in (4) sizes, 3cc, 5cc, 10c and 30cc, the HPD is ideal for any application where hand syringes are used.

Key

- Recommended
- ▲ Satisfactory
- Do not use

Models	Fluid compatibility												
	anaerobics	cyanoacrylates	gel cyanoacrylates	white glue	epoxies	inks	grease	oils	sealants	silicones	solder/braze pastes	solvents	UV cure
DG	▲	■	▲	●	●	■	●	■	●	●	●	■	●
HPD	▲	■	▲	●	●	●	●	▲	●	●	●	■	●

Ultra Dispense Components

The correct selection of syringe barrel, piston and dispense tip provides complete fluid application control, safe, easy, no drip or ooze.

pistons

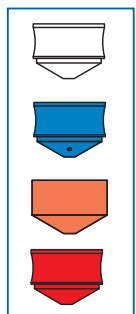
- 
- Low-friction, inert polymer PE piston with double-wiper action ensures clean, smooth emptying of syringe barrel without drip or ooze.
 - Special LV Barrier™ for cyanoacrylates, solvents and watery fluids.
 - Smooth-wall SPE piston prevents tunneling and stringing of pastes and sealants.
 - Designed for Ultra 2800 positive displacement system, red piston ensures snug fit with the 2800 plunger.

syringe barrels

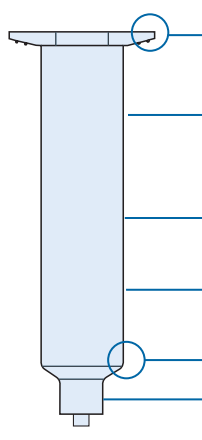
- 
- Unique reinforced flange design ensures positive attachment to adapter.
 - Precision-molded proprietary polypropylene syringe barrels with thick walls prevent cracking or rupturing, and provide excellent chemical compatibility.
 - Available in clear; light-block amber for UV-cure; and opaque black.
 - Engineered 0° taper internal bore provides complete wiping and controlled dispensing.
 - Internal radius provides smooth-flow dispensing.
 - Threaded sleeve makes positive seal with SafetyLok™ tips and caps.

dispense tips

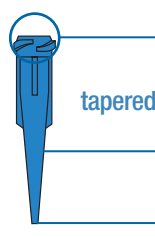
- 
- tapered**
- Unique 360° SafetyLok™ thread ensures safe, positive attachment to the barrel.
 - Internal taper provides smooth fluid flow.
 - No burrs and flash free means accurate deposits.

polypropylene

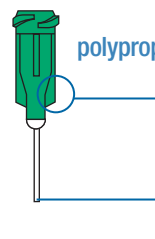
- 
- Large flats for easy twist-on, twist-off.
 - Flexible polypropylene tubing bends into recesses, prevents scratching, and spreads fluids easily.

stainless steel

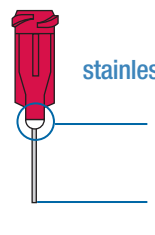
- 
- Unique hub design ensures close-tolerance overall tip length and precise tubing alignment.
 - Burr-free, polished stainless steel tube opening for undisturbed liquid deposits.



Benefits

- ◆ Molded silicone-free
- ◆ Certified safe for industrial use
- ◆ Positive dispense cutoff
- ◆ Disposable, no cleanup
- ◆ Closed system
- ◆ High-strength copolymer

Shipments

All Ultra components are shipped from stock within 24 hours of receipt of order.

Quality Assurance

EFD certifies that all EFD components are designed for safe industrial operation when used in accordance with our technical data, manuals and brochures. EFD certifies that all components are precision molded in an EFD silicone-free facility.

Barrel dimensions

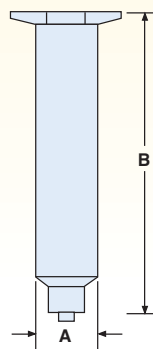

	A	B
3cc	7/16"	2 7/8"
5cc	9/16"	2 11/16"
10cc	3/4"	3 1/2"
30cc	1"	4 9/16"
55cc	1"	6 13/16"

Disposable Reservoir System



Five sizes, three colors and four types of syringe barrels/pistons make up the Ultra reservoir system for proper dispensing of all kinds of assembly fluids.

For samples, recommendations and immediate customer service:
800-556-3484 www.efd-inc.com/samples

Syringe barrel & piston sets

QTY	MOST FLUIDS			Light Block*	Opaque
	Clear Barrels White Pistons	Clear Barrels Blue LV™ Barrier	Clear Barrels Red Pistons	Amber Barrels White Pistons	Black Barrels White Pistons
3cc (50)	5109CP-B	5109LV-B	5109CPD-B	5109LBP-B	5109UP-B
5cc (40)	5110CP-B	n/a	5110CPD-B	5110LBP-B	5110UP-B
10cc (30)	5111CP-B	5111LV-B	5111CPD-B	5111LBP-B	5111UP-B
30cc (20)	5112CP-B	n/a	5112CPD-B	5112LBP-B	5112UP-B
55cc (15)	5113CP-B	n/a	n/a	5113LBP-B	5113UP-B

Reservoirs available in clear for most fluids; translucent amber for UV and light-sensitive materials (*240 to 550 nm); and opaque black to ensure complete light blockage.

Amber barrels also available with red pistons; request the LBP series. LV Barrier sets include tip caps and are designed for cyanoacrylate and very low viscosity fluid dispensing. Red PD pistons are for use with the Ultra 2800 positive displacement system.

Storage end/tip caps

QTY	End Cap
3cc (50)	5109EC-B
5cc (40)	5110EC-B
10cc (30)	5111EC-B
30cc (20)	5112EC-B
55cc (20)	5112EC-B

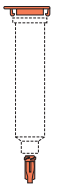

QTY	Tip Cap
All sizes (50)	5113-B

Snap-on end cap for leakproof barrel sealing. Opaque SafetyLok™ tip caps fit all barrel sizes.

Syringe barrels without pistons

QTY	Clear Barrels	Light Block Amber Barrels	Opaque Black Barrels
3cc (50)	5109LL-B	5109LB-B	5109UV-B
5cc (40)	5110LL-B	5110LB-B	5110UV-B
10cc (30)	5111LL-B	5111LB-B	5111UV-B
30cc (20)	5112LL-B	5112LB-B	5112UV-B
55cc (15)	5113LL-B	5113LB-B	5113UV-B

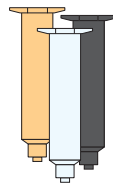

Note: Order appropriate SmoothFlow pistons separately.

SmoothFlow™ barrel pistons

QTY	White PE	Blue LV	Orange SPE	Red
3cc (50)	5109PE-B	5109LVP-B	5109SPE-B	5109PDP-B
5cc (40)	5110PE-B	n/a	5110SPE-B	5110PDP-B
10cc (30)	5111PE-B	5111LVP-B	5111SPE-B	5111PDP-B
30cc (20)	5112PE-B	n/a	5112SPE-B	5112PDP-B
55cc (20)	5112PE-B	n/a	5112SPE-B	5112PDP-B



Pistons ensure constant dispensing force, prevent drip or ooze, contain hazardous fumes and empty all fluid from barrel.

Adapter assemblies

QTY	Yellow Acetal 3-ft. Hose	Yellow Acetal 6-ft. Hose	Yellow Acetal 3-ft. Hose/Trap
3cc (1)	1000Y5148	1000Y5148-6	1000Y-5148-F
5cc (1)	1000Y5149	1000Y5149-6	1000Y-5149-F
10cc (1)	1000Y5150	1000Y5150-6	1000Y-5150-F
30/55cc (1)	1000Y5152	1000Y5152-6	1000Y-5152-F

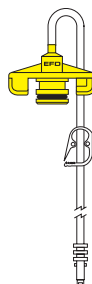

One-piece molded SnapLok™ adapter provides safe attachment of syringe barrel. Includes 5/32" OD flexible polyurethane tubing, Buna N O-ring, quick-connect and safety clip.

Note: Refer to price list for replacement parts.

ESD-safe components

Unique barrel/dispense tip/adaptor systems are manufactured to ensure static electricity is dissipated, offering high conductivity and low carbon black loading. ESD-safe components are ideal for dispensing adhesives and epoxies in electronics, disk drive and SMT production.

Free samples and ESD Test Report:

Call 800-556-3484 or visit www.efd-inc.com/esd

“We have made a **huge leap** from bottleneck to high production.” Pat Welch, Ethicon Endo Surgery

Precision Dispense Tips



After choosing the most appropriate dispenser and barrel/piston combination, the deposit is defined by the type of dispense tip selected.

Each EFD tip is precision made, without burrs or flash, to produce the very best deposit control.



Transparent boxes keep tips clean, handy and easy to identify.

Smooth-flow tapered tips (50 tips per box)

gauge	standard	opaque rigid	color
14	5114TT-B	5114RTT-B	Olive
16	5116TT-B	5116RTT-B	Grey
18	5118TT-B	5118RTT-B	Green
20	5120TT-B	5120RTT-B	Pink
22	5122TT-B	5122RTT-B	Blue
25	5125TT-B	5125RTT-B	Red



Use with gel cyanoacrylates, UV-cure adhesives, sealants, and particle-filled materials or any medium to high viscosity fluid. Molded of polyethylene with UV-light block additive.

Flexible tips (50 tips per box)

gauge	0.50"	1.5"	color
15	5115PPS-B	5115PP-B	Amber
18	5118PPS-B	5118PP-B	Green
20	5120PPS-B	5120PP-B	Pink
25	5125PPS-B	5125PP-B	Red

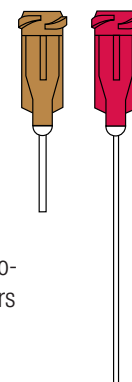

Flexible polypropylene tubing for application into difficult-to-access areas. Easily drags along edges and around corners and prevents scratching. Tubing can be cut to length.

Precision stainless steel tips (50 tips per box)

gauge	0.25"	0.50"	1.0"	1.5"	45°/0.5"	90°/0.5"	45°/1.5"	color
14	5114-0.25-B	5114-B	5114-1-B	5114-1.5-B	5114-B-45	5114-B-90	2173-B	Olive
15	5115-0.25-B	5115-B	5115-1-B	5115-1.5-B	5115-B-45	5115-B-90	n/a	Amber
18	5118-0.25-B	5118-B	5118-1-B	5118-1.5-B	5118-B-45	5118-B-90	2174-B	Green
20	5120-0.25-B	5120-B	5120-1-B	5120-1.5-B	5120-B-45	5120-B-90	n/a	Pink
21	5121-0.25-B	5121-B	5121-1-B	5121-1.5-B	5121-B-45	5121-B-90	2175-B	Purple
22	5122-0.25-B	5122-B	5122-1-B	5122-1.5-B	5122-B-45	5122-B-90	n/a	Blue
23	5123-0.25-B	5123-B	5123-1-B	5123-1.5-B	5123-B-45	5123-B-90	n/a	Orange
25	5125-0.25-B	5125-B	5125-1-B	5125-1.5-B	5125-B-45	5125-B-90	n/a	Red
27	5127-0.25-B	5127-B	n/a	n/a	5127-B-45	5127-B-90	n/a	Clear
30	5130-0.25-B	5130-B	n/a	n/a	5130-B-45	5130-B-90	n/a	Lavender
32	5132-0.25-B	n/a	n/a	n/a	n/a	n/a	n/a	Yellow

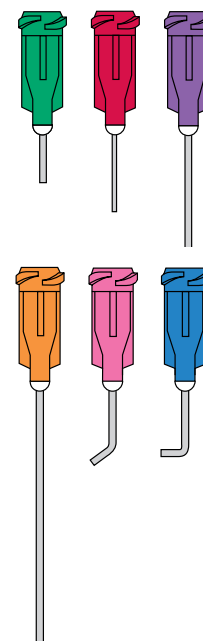



Burr-free, polished, passivated stainless steel dispense tips with polypropylene SafetyLok™ hubs for a secure fit to barrel reservoirs. • 0.25" tips: Fast point-to-point dispensing. • Smaller gauges ideal for microdots. • 0.50" tips: Standard all-around precision dispense tips. • 1", 1.5", 45° and 90° tips: Easy access into hard-to-reach areas.



For recommendations, free samples and application assistance, call 800-556-3484 or go to www.efd-inc.com/samples

Precision Dispense Tips

PTFE-lined tips (50 tips per box)

ID	0.50"	1.0"	color	
0.020"	5121TLCS-B	5121TLC-B	Grey	
0.006"	5125TLCS-B	5125TLC-B	Pink	

Resists clogging of cyanoacrylates.
Use for microdot application of low viscosity fluids.

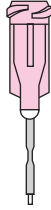

Oval tips (50 tips per box)



gauge	0.50"	color	
15	51150VAL-B	Amber	

Makes flat ribbon deposits of thick pastes, sealants and epoxies.

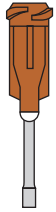
Outlet size is .078" x .016" (1.98 x 0.41 mm).



PTFE-coated tips (20 tips per box)

gauge	ID	OD	0.50"	color	
21	0.020	0.033	5121PC-B	Purple	
23	0.013	0.026	5123PC-B	Orange	

Controls wicking to stop drips for optical media applications.







Brush tips (sold individually)

style	standard	high flow
soft bristle	5140A	5140HF
stiff bristle	5141A	5141HF

Spread glues and greases. Nylon bristles, 2" length.



Chamfered tips (50 tips per box)



gauge	0.50"	color	
18	5118CH-B	Green	
23	5123CH-B	Orange	
25	5125CH-B	Red	
33	5133MD-B*	Clear	

Resists clogging of cyanoacrylates.
Use for microdot application of low viscosity fluids.

*5133MD-B is 0.25" long









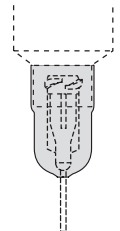





Tip shields (10 shields per box)

size	shield	color	
3cc	5105	Red	
5cc to 55cc	5106	Black	

Reusable tip shields for light-sensitive and UV-cure adhesives. Fits over dispensing tip hub.



Color coding for tip sizes

Color	Gauge	Inner Dia.		Outer Dia.	
		inch	mm	inch	mm
	Olive 14	0.060	1.55	0.072	1.83
	Amber 15	0.054	1.37	0.065	1.65
	Grey 16	0.047	1.19	n/a	n/a
	Green 18	0.033	0.84	0.050	1.27
	Pink 20	0.023	0.61	0.036	0.91
	Purple 21	0.020	0.51	0.032	0.81
	Blue 22	0.016	0.41	0.028	0.71
	Orange 23	0.013	0.33	0.025	0.64
	Red 25	0.010	0.25	0.020	0.51
	Clear 27	0.008	0.20	0.016	0.41
	Lavender 30	0.006	0.15	0.012	0.30
	Yellow 32	0.004	0.10	0.009	0.23

Note: OD dimensions: stainless tips only

Whatever tip style, all sizes are color coded to ensure the specified size is used.



Free Syringe & Tip Poster for Adhesive Dispensing.

Quickly identify the right dispensing components for your fluid application process.

Chart shows how to select the best syringe & tip combination to ensure complete fluid control. Post in tool cribs and at workstations.

Call 800-556-3484, or request online at www.efd-inc.com/poster

All shipments made within 24 hours.

Precision Dispense Tips Selection



Taking time to match your specific application requirement and assembly fluid with the most suitable dispense tip is well worth the effort. We supply an appropriate assortment of tip types and sizes with each dispenser and valve.

For additional samples or recommendations and immediate customer service:

800-556-3484 www.efd-inc.com/samples

Applications	Liquid/fluid/paste			
	tapered	precision stainless steel tube	flexible	crimped Teflon®-lined
Very low viscosity fluids	■	●	●	●
Particle-filled pastes	●	●	▲	■
Microdot deposits	■	●	▲	●
Fluid is reactive to metal	●	■	●	●
Depositing in recesses	▲	●	●	▲
Spreading/smearing	●	▲	●	▲
Fast-curing glues	●	▲	●	●
Beading, striping	●	●	●	▲
To avoid scratching	●	▲	●	●

Liquid/fluid/paste	Applications			
	tapered	precision stainless steel tube	flexible	crimped Teflon®-lined
Adhesives	●	●	●	●
Anaerobics	●	▲	●	▲
Conformal Coatings	●	▲	▲	■
Cyanoacrylates	●	▲	●	●
Gel cyanoacrylates	●	▲	●	▲
Epoxies	●	●	●	■
Greases	●	●	●	■
Light-cure adhesives	■	▲*	▲*	■
Oils	▲	●	●	▲
Paints	▲	●	●	■
Sealants	●	▲	▲	■
Silver epoxy	■	▲+	■	■
Solder creams/braze pastes	●	●	▲	■
Solder masks	●	●	▲	■
Solvents	■	●	●	●
UV-cure adhesives	●	▲*	▲*	▲

Key

- Recommended
- ▲ Satisfactory
- Do not use

* OK if used with tip shield, part# 5105 or 5106. See page 14.

+ Chamfered tips are recommended for best results.

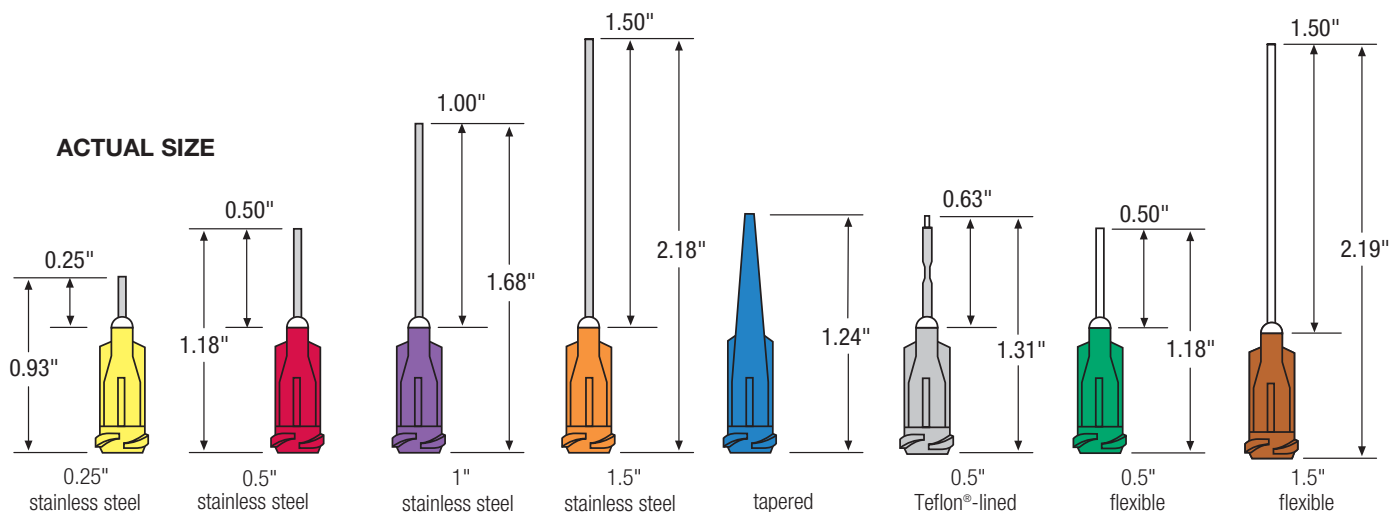

Cartridge Systems



The EFD Cartridge System is useful when reservoir capacity larger than 55cc is required. Attached to any EFD air-powered dispenser, cartridges can be used for timed and “by-eye” dispensing for potting and beading. Precision molded nylon retainer and cap provide safe dispensing pressure up to 100 psi. The Cartridge System is not recommended for small, repeat timed deposits.

For more information and assistance, call 800-556-3484.

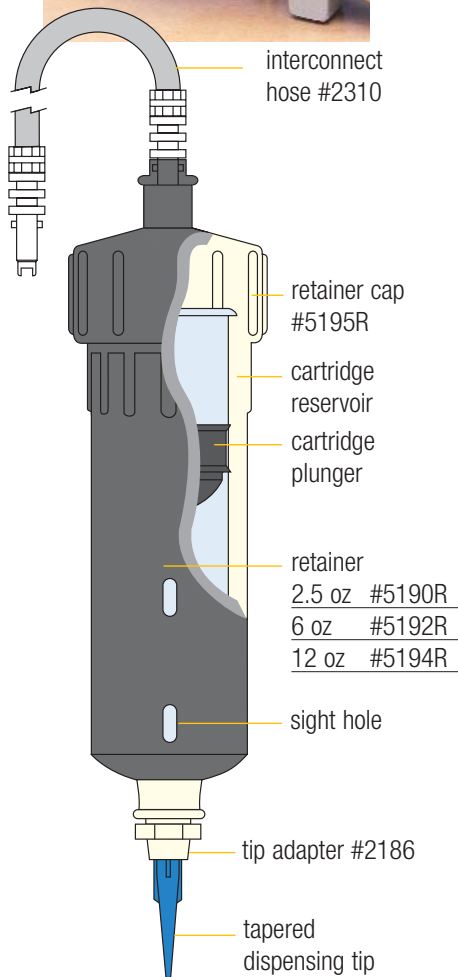

Cartridge reservoir assembly

size	order #
2.5	5190-2.5
6	5192-6
12	5194-12

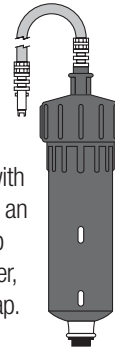

Includes 5-ft connecting hose with male quick-connect to plug into an EFD dispenser, retainer cap, cap gasket, retainer, cartridge, plunger, tip adapter, end cap and outlet cap.

Nozzles (10 per bag)

size	order #
2.5 x .125"	5180-B
2.5 x .062"	5181-B
4.0 x .062"	5182-B
4.0 x .031"	5183-B



Polypropylene nozzles thread into all cartridge sizes; 1/4-inch NPT thread.

Disposable cartridge reservoirs

cartridge item	order #
2.5 oz cartridge reservoir	5190C
6 oz cartridge reservoir	5192C
12 oz cartridge reservoir	5194C
cartridge plunger, one size fits all	5196
cartridge retainer cap gasket	5195G
cartridge tip adapter	2186



All parts are packaged separately. The cartridge reservoir is molded polyethylene. The retainer cap gasket is EPR.

1/10 gallon cartridge assembly for caulking tubes

description	order #
1/10 gallon caulking cartridge assembly	5201-SYS

Complete system to accept caulking type cartridge includes 5-ft. connecting hose, retainer cap, retainer, tip and nozzle adapters.



Cartridge reservoir

	A	B
2.5 oz	3 7/8"	1 15/16"
6 oz	7 1/16"	1 15/16"
12 oz	12 1/4"	1 15/16"

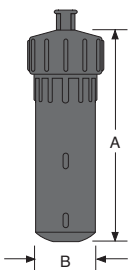

For details on optional pistol grip and production stand, please refer to the EFD Ultra Price List.

Syringe Barrel Loaders

Pourable fluids are easy. Just fill the barrel. For best results, fill up to 50% of the barrel capacity.

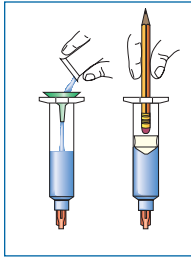

920/940 Series syringe barrel loader

For nonpourable fluids, including grease, pastes, sealants, and others, manually load or use an EFD syringe barrel loader.

With the #920BL barrel loader, pack the fluid into a 12 ounce cartridge. Then place the pre-filled cartridge into the barrel loader. Using air pressure, the barrel loader fills the syringe barrel (with piston installed) from the bottom up.



If the fluid comes packed in a 1/10 gallon (300 ml.) caulking type cartridge, use the EFD #940BL barrel loader.

If you receive frozen epoxies or other fluids in medical type syringes with a manual plunger, request the EFD luer-to-luer fitting #2160 to transfer the material.

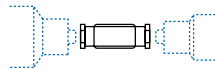

EFD valve system

For cyanoacrylates, consider transfer from 1 lb bottles to barrels using our 752V valve system, or incorporate a controller to provide exact fills automatically.

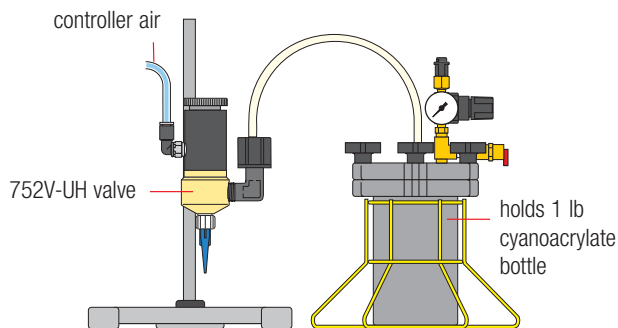

8000BF automated filling station

For automatic filling of barrels, our 8000BF system makes this operation fast, easy, accurate and clean. The 8000BF can be configured several ways to meet your specific needs.

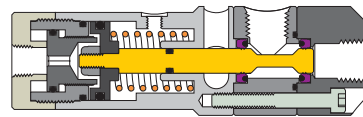

8000BF-HPA for use with fluid supply pressures above 100 psi (6.9 bar).

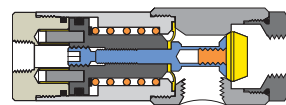

8000BF-HF for use with cartridge and tank reservoirs at fluid supply pressures up to 100 psi (6.9 bar).

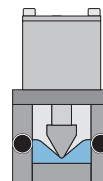

8000BF-PW for use with reactive fluids that require disposable fluid path — up to 80 psi (5.5 bar) fluid supply pressure.

Productivity Tools & Accessories

Choose from a wide range of optional tools to maximize your dispensing system.

Flexible arm syringe barrel holder

Mounts to dispenser cabinet; can be adjusted to multiple positions. For Ultra 2400, 1400 and 870 Series dispensers. **#2429**



Workstation lamp

Mounts on flex arm and provides targeted lighting on work area. For Ultra 2400 Series dispensers. **#2437**



Stiff arm syringe barrel holder

Mounts to Ultra dispenser cabinet and holds barrel in a fixed position. For Ultra 2400, 1400 and 870 Series dispensers. **#2434**

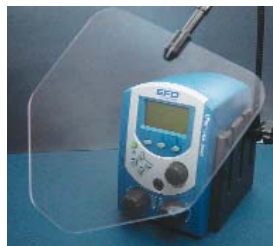

Safety shield

Provides splash-guard protection when dispensing toxic fluids. For Ultra 2400 and 2800 Series dispensers. **#2436**

Ergonomic hand grip with finger switch/light

Trigger the dispense cycle from this grip with built-in touch sensor and high beam penlight. Fits all EFD syringe barrels. For Ultra 2400 Series dispensers, patent# U.S. 6,938,795 B2. **#2440FS**



Production extension shelf

Provides flat work surface for other tools or dispenser stacking. For Ultra 2400 Series dispensers. **#2443**

Magnifying lens

1.7x magnification mounts on flex arm; perfect for assembly of small parts. For Ultra 2400 and 2800 Series dispenser. **#2442**

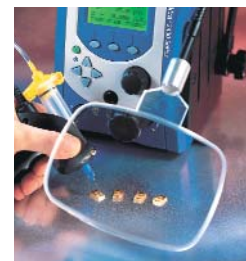

Ergonomic hand grip

Hand grip only without finger switch (for all dispensers) **#2441**



Syringe barrel production stand

Provides full-barrel swivel, horizontal and vertical adjustment. Accepts all EFD barrels. **#7300A**

I/O connector assembly

Allows easy connection to the dispenser for external control. One end has a male DIN connector; opposite end connects to external devices. **#2446** 8-pin connector for Ultra 2400 and 2800 Series; **#7154** 9-pin connector for Ultra 1400 Series.

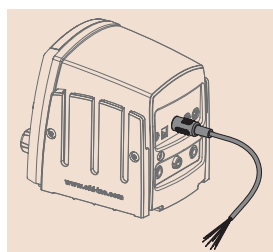

Finger switch

Low voltage, push button finger switch controls dispense cycle. Fits all EFD syringe barrels. For Ultra 1400 Series dispensers. **#2015FS**



“When it came time to upgrade our dispensers... Called EFD and they gave me a **trade-in credit for my old equipment.**” Technical Group

Liquid filter trap

Prevent fluid from being sucked back into the dispenser. **#2435** for the Ultra 2400 Series; **#1000FLT-Y** for the Ultra 1400 and Ultra 870 Series.

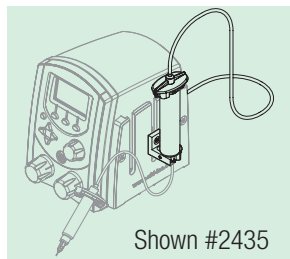

Mikros™ pen system

Unique 0.25cc fluid reservoir is built into the Mikros tip for dispensing microdots of 2-part epoxies, UV-cure and high performance adhesives. Mix in small batches and fill, and save on fluid costs. **#5800MP-SYS**

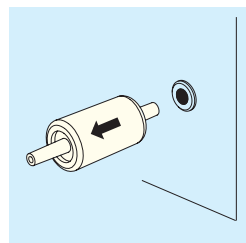

Cleanroom filter muffler

Designed for cleanrooms and other demanding production areas. Attaches to Ultra dispenser exhaust port and filters output air to meet Fed 209-B (0.5 micron particulates). **#2400FT** for the Ultra 2400 Series; **#2170FT** for the Ultra 1400 and Ultra 870 Series.

Vacuum pickup pen system

Convenient all-in-one vacuum generator and pen system makes it easy to pick-and-place small parts. Connects to an air-powered Ultra dispenser to generate steady vacuum force. Includes complete kit. **#2455**



Five-micron regulator

Required for production areas where clean, dry, filtered factory air is not available, or to stabilize plant air supply for more consistent deposits. **#2000F755**

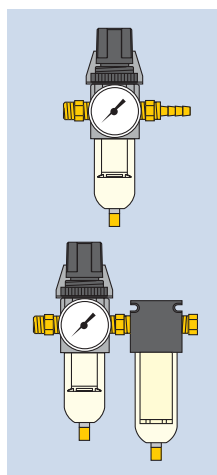

Five-micron regulator with coalescing filter

Recommended for systems dispensing cyanoacrylates. Removes liquid aerosols from air supply. **#2000F756**



Vacuum generator with pickup pen

Vacuum on/off foot pedal provides a steady hand for pick-and-place function. Includes complete kit with pickup pen. Accepts all EFD syringe barrels. **#10VAC**

Pickup tool

Hand-operated VACTweezer picks up any smooth object. Includes complete kit with pickup tool. **#VACTweezer**



HPx high pressure dispensing system

Produces up to 700 psi of pressure in an EFD syringe barrel when connected to a standard 100 psi dispenser. Apply precise amounts of thick RTV silicones, medical adhesives and epoxies through small gauge tips. **#HP7x** (3cc) or **#HP4x** (10cc)



Dispensing tip sampler kit

The 140-piece kit includes samples of standard and special-purpose EFD dispensing tips, SmoothFlow pistons, barrel tip caps, end caps and detailed Ultra Guide booklet. **#5100**

“If every component in the USA had the same level of quality in their products and the same **commitment to customer service** as EFD, there would be no question about the global competitiveness of our country.” Scott Webb, ITW Chromatic

More EFD Products

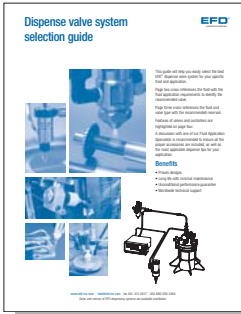

Precision Dispense Valves

Engineered for the most demanding mechanical and environmental applications, EFD low-maintenance valve systems provide very reliable dispensing solutions for benchtop applications, automated lines and machine builders.

800-556-3484 info@efd-inc.com



Ultra™ TT XYZ System

EFD's Ultra™ TT xyz dispensing systems increase productivity by combining precise assembly fluid application with fast, accurate automated positioning. Easily programmed with a PDA handheld.

**800-556-3484
automation@efd-inc.com**

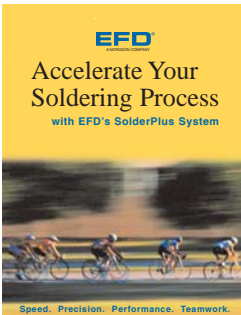

SolderPlus®

Switching from flux-cored wired to SolderPlus provides better quality solder joints with reduced costs. SolderPlus dispensed with air-powered dispensing systems delivers precise, repeatable deposits at high speeds without waste.

**800-338-4353
solder@efd-inc.com**

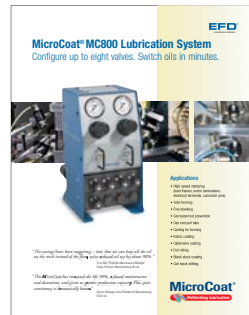

MicroCoat® Lubrication System

EFD's MicroCoat precision LVLPL lubrication system was specifically developed for the metal stamping industry. The MicroCoat system applies the exact amount in a fine, even film. Tools last longer and presses run faster.

**800-498-8865
microcoat@efd-inc.com**

Call 800-556-3484 for assembly fluid application recommendations or for any of the above brochures.

www.efd-inc.com

Since 1963, EFD dispensing systems have helped thousands of companies make precise deposits of adhesives, lubricants and other assembly fluids.

Innovative design, unparalleled product performance, unwavering commitment to quality, and old-fashioned customer support make EFD the leader in the diverse markets we serve.

Today, the company does business on the same principles on which we were founded: to help our customers make better products, in less time, at lower cost.

We invite you to learn more, and look forward to working with you.



**For application assistance in the USA,
call 800-556-3484.**

For EFD sales and service in over 30 countries, contact EFD USA or go to www.efd-inc.com/contact

EFD, Inc., a Nordson Company
977 Waterman Avenue
East Providence, RI 02914-1342 USA

telephone +1-401-434-1680 fax +1-401-431-0237
info@efd-inc.com www.efd-inc.com

EFD, ULTRA, SolderPlus, MicroCoat, SmoothFlow, DispensGun, SafetyLok, SnapLok, LV Barrier, VACTweezer, HPx and Mikros are trademarks of EFD, Inc. Note: Specifications and technical details are subject to change without prior notification. v011206 ©2005 EFD, Inc.